

SEQUENTIAL CIRCUITS

SIX-TRAK

OPERATION MANUAL



SIX-TRAK
SYNTHESIZER/SEQUENCER
OPERATION MANUAL

By Stanley Jungleib

Sequential Circuits, Inc.
Nijverheidsweg 11c
3641 RP Mijdrecht
Netherlands
02979-6211
TELEX: 12721 SQNTL NL

Sequential Circuits, Inc.
3051 North First Street
San Jose, CA 95134-2093
U.S.A.
408/946-5240
TELEX: 364412 INTR 706

SIX-TRAK
MODEL 610

OPERATION MANUAL

by Stanley Jungleib

Art Assistance: Jay Oglevee

Manual No. CM610A
Issued: December, 1983

©1983 by
SEQUENTIAL CIRCUITS, INC.
All rights reserved.

About the Six-Trak

The multi-timbred Six-Trak puts in your hands a compact, affordable new musical tool with functions until now provided only by a synthesizer together with a multi-track tape recorder. In contrast to homophonic synthesizers, which program each voice with the same sound, each of the Six-Trak's voices can have a different sound. This enables the creation of complex ensembles, which are recorded on the Six-Trak's sequencer. The sequencer allows overdubbing, editing, and duplication without re-recording, splicing, or accumulating noise and distortion by "mixing-down" and "bouncing" generations of tape tracks.

The Six-Trak has a four-octave keyboard which you can use to overdub tracks, to play one or more voices live along with recorded sequences, or to play six voices live playing when in homophonic mode (polyphonic or unison). Other keyboard modes include a legato function, voice stacking, and a flexible arpeggiator.

The 800-note memory can be allocated to two sequences. Sequencer functions include overdubbing, programmable playback speed, programmable track volume, track erase, and warning of memory-full.

The synthesizer program memory stores 100 programs, each consisting of 33 voice parameters. 100 instrumental sounds and effects are factory-programmed, but the player can modify (edit) these as desired. LEDs clearly indicate the selected program, and if the program is being edited, they also display the parameter number and parameter value. Parameter values are edited with a signal knob. Programs can be copied. And the non-volatile memory is retained when power is off, thanks to a ten-year backup battery.

Each voice has a multi-waveform oscillator (or noise) as the principal sound source. The oscillator drives a resonant low-pass filter which contours the timbre, and an amplifier which contours the dynamics. There are three attack-decay-sustain-release (ADSR) envelope generators: for oscillator frequency, filter cutoff frequency, and amplifier gain. (The polarity of the first two can be inverted.) A triangle or square wave modulation low frequency oscillator (LFO) can be applied to oscillator frequency, pulse width, or filter frequency. Modulation depth can be programmed or adjusted by the MOD wheel. A second modulation route runs from the oscillator triangle output to the filter frequency. Frequency glide ("portamento") and voice volume are programmable. A PITCH wheel is provided for bending notes. Non-programmable master volume and tuning controls are provided. The TUNE switch has been eliminated by fully-automatic oscillator tuning.

The back panel has jacks for audio output (which can drive stereo headphones); a multi-purpose control footswitch; and MIDI input and output. MIDI is the link to the future. Today it allows the integration of the Six-Trak into one programmable system including SCI's new Drumtraks and Model 64 MIDI sequencer. The synchronous link to the Drumtraks adds an entire programmable rhythm section to the multi-timbred ensemble. The Model 64 sequencer offers increased sequencer storage (up to 4000 notes), program storage on cassette or disc, sequence transposition, and alternate keyboard modes, as well as forthcoming music display and editing functions.

The Six-Trak is another new concept from Sequential Circuits, the leader in affordable high-technology for the electronic musician.

Table of Contents

	<u>page</u>
About the Six-Trak	iii
1 BASIC SETUP	1-1
2 BASIC OPERATION	
2-1 PREPARATION	2-1
2-2 PROGRAM SELECT	2-2
2-3 WHEELS	2-2
2-4 AUTOMATIC TUNING	2-3
2-5 MANUAL TUNING	2-3
2-6 NORMAL VOICE ASSIGNMENT	2-3
2-7 UNISON	2-3
2-8 LEGATO	2-4
2-9 GLIDE	2-4
2-10 IN CASE OF DIFFICULTY	2-4
3 SEQUENCER	
3-1 INTRODUCTION	3-1
3-2 PLAYBACK START/STOP	3-2
3-3 OPTIONAL FOOTSWITCH START/STOP	3-3
3-4 TRACK VOLUME	3-3
3-5 MEMORY FULL	3-4
3-6 RECORD BASIC TRACK(S)	3-4
3-7 RECORDING USING THE OPTIONAL FOOTSWITCH	3-6
3-8 BASIC OVERDUBBING	3-7
3-9 ERASING TRACKS	3-8
3-10 FOOTSWITCH CUE	3-8
3-11 EDIT TRACK PROGRAM	3-9
3-12 MULTI-TRACK/MULTI-TIMBRE EXAMPLE	3-10
3-13 IN CASE OF SEQUENCER PROBLEMS	3-12
4 ARPEGGIATOR	
4-1 INTRODUCTION	4-1
4-2 UP/DOWN	4-1
4-3 ASSIGN	4-2
4-4 FOOTSWITCH NOTES	4-2
5 STACK MODE	5-1
6 PROGRAMMING THE SYNTHESIZER	
6-1 INTRODUCTION	6-1
6-2 EDITING A PROGRAM	6-2
6-3 RESTORING A PROGRAM	6-2
6-4 AN EDITING EXAMPLE	6-3
6-5 RECORDING A PROGRAM	6-5
6-6 USING THE BASIC PATCH	6-6

		<u>page</u>
7	SYNTHESIZER PARAMETERS	
7-1	INTRODUCTION	7-1
7-2	OSCILLATOR	7-3
7-3	LFO	7-7
7-4	FILTER	7-8
7-5	AMPLIFIER	7-11
7-6	UNISON	7-11
8	HIDDEN FUNCTIONS	
8-1	GENERAL	8-1
8-2	MIDI	8-2
8-3	FOR SERVICE USE ONLY	8-2
9	USING THE SIX-TRAK WITH DRUMTRAKS	9-1
10	USING MIDI	
10-1	CONNECTING TWO SIX-TRAKS	10-1
10-2	BASIC MIDI OPERATION	10-2
10-3	DUMP OPERATIONS	10-2
10-4	CONTROL OPTIONS	10-3
10-5	A SIX-TRAK AND PROPHET-T8	10-4
11	DETAILS	11-1
12	SPECIFICATIONS	12-1
13	MIDI IMPLEMENTATION SPECIFICATION	13-1
14	FACTORY PROGRAMS	14-1
15	YOUR PROGRAMS	15-1

1 BASIC SETUP

WARNING! Switch power off to all equipment in use before connecting or disconnecting anything.

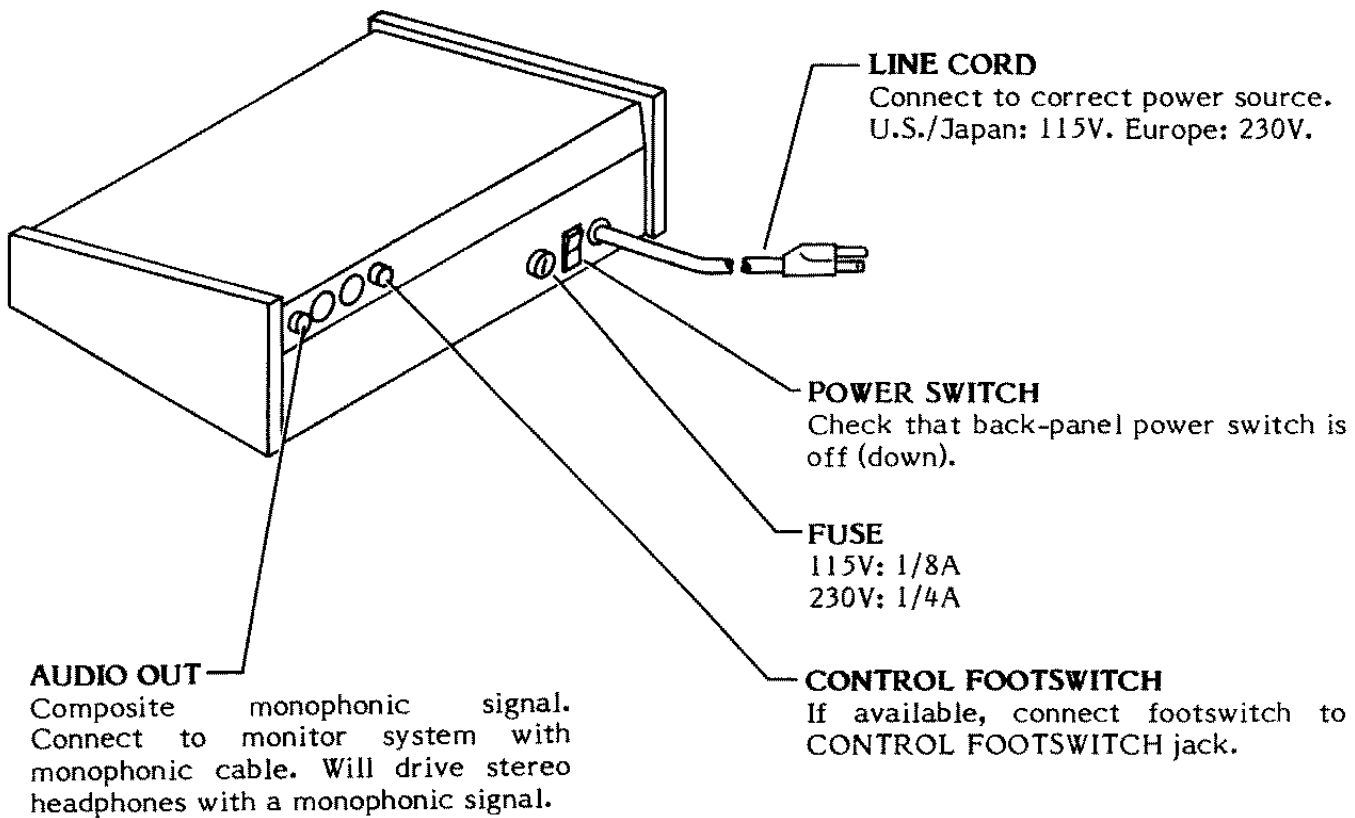

Figure 1-1
BASIC SETUP

2 BASIC OPERATION

This section covers basic operation using the factory programs.

2-1 PREPARATION

Connect the Six-Trak as described on the previous page.

Switch power on.



It is normal for 00 to be displayed and PROGRAM to be lit.

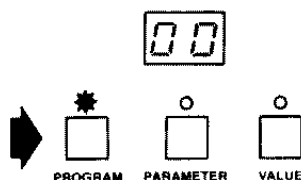

(If there is a memory error, the display will count from 1 through 6. This indicates voice tuning. Also, any sequences will be erased. See page 2-4.)

CAUTION: To protect speakers (and ears!), first lower MASTER VOLUME all the way, then raise it to desired level while playing.

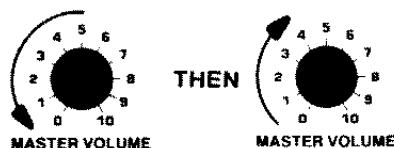

Since program 00 has been pre-programmed, the keyboard will now play in this sound. The keyboard will be homophonic: all voices will be programmed with #00.



Check that PITCH wheel is centered in its detent position.

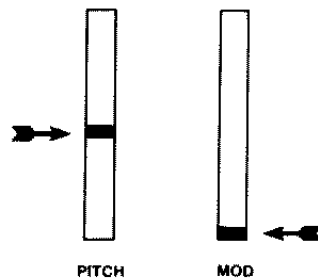

Check that the MOD wheel is fully down.

Check that MASTER TUNE is centered.

If necessary, adjust MASTER TUNE to tune Six-Trak against piano or other instrument.

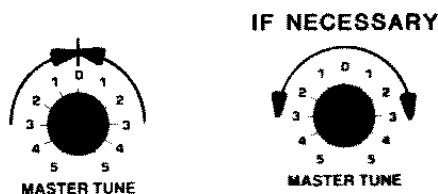

2-2 PROGRAM SELECT

To select a new program:

Switch PROGRAM on (if not already). This enables program changes to be made and indicates that the display is showing a program number.

When PROGRAM is lit, pressing any two digits will select a new program.

The new program takes effect when the second digit is entered.

If the sequencer and arpeggiator are off, pressing the footswitch will select the next highest program number.

The factory programs are described at the back of this manual.

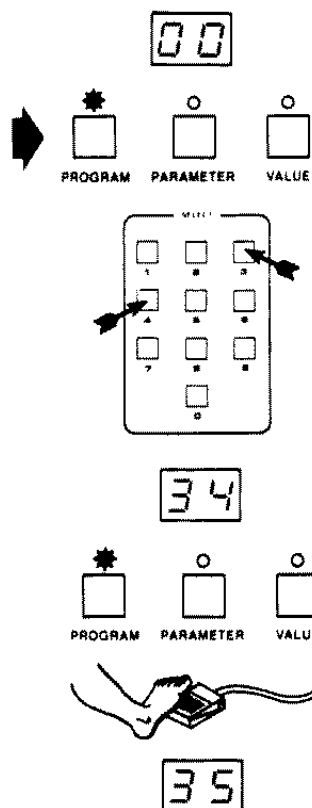

2-3 WHEELS

The PITCH wheel is normally left in its center-detent position, from which it is possible to "bend" oscillator pitch up or down by about a 3rd.

Check that the MOD wheel is down (minimum modulation). The MOD wheel sets the modulation level. When not in use, the wheel is left "down" and no modulation will occur. When the wheel is advanced fully "up," modulation is maximum.

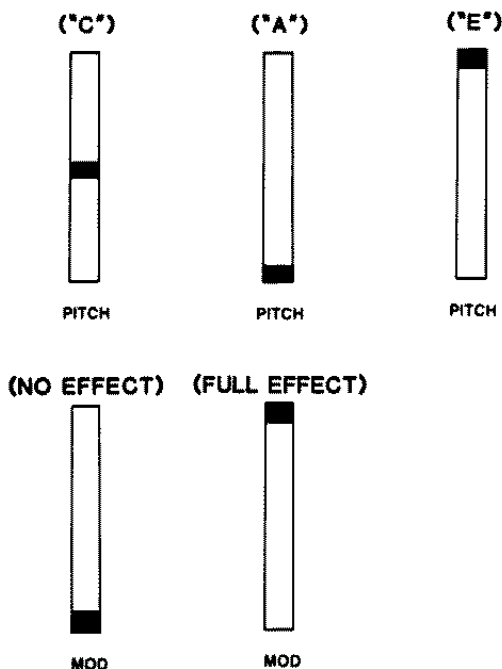

2-4 AUTOMATIC TUNING

As the Six-Trak warms up, the temperature change causes the oscillators to drift. To correct for this effect, the Six-Trak tunes itself when it is not being played. When the Six-Trak has been "standing by" for 30 seconds, it will tune one oscillator. Thirty seconds later, it will tune the next oscillator, and so on. If you need to play it while it is tuning, go ahead: playing interrupts tuning.

2-5 MANUAL TUNING

If you do not want to wait for automatic tuning to tune the six oscillators:

Hold CONTROL RECORD.
Press SELECT 6.

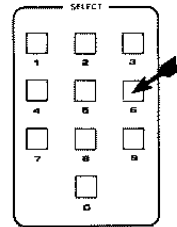
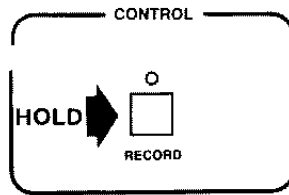

RECORD will remain lit while tuning is in progress. The display will count from 1 to 6, indicating which voices are tuning. When tuning is concluded, RECORD will go off and the Six-Trak will return to exactly the same state as it was in before the tuning. Even unrecorded Edit Mode changes are retained. It may be necessary to slightly readjust MASTER TUNE.

2-6 NORMAL VOICE ASSIGNMENT

Voice assignment is indicated by the TRACK LEDs (TRACK 1 equals voice 1, etc.).

While you play normally, the computer continuously assigns the six synthesizer voices to the most recently-played keys on the keyboard. You can play a maximum of six keys at once. If more than six keys are held down at the same time, the computer will reassign the earliest-used voices first. For example: playing and holding C, D, E, F, G, A, and B in succession will result in D, E, F, G, A, and B being sustained, while the C will disappear when the B is played. In other words, the Six-Trak normally operates on a "last-note priority" system: each new note played is assigned to the earliest-used voice. If the same key is struck repeatedly, the computer assigns the same voice.

2-7 UNISON

While selecting factory programs, you may have noticed the keyboard switching to Unison mode. If Unison is on in the current program, all six voices will be assigned to the lowest key played.

In Unison, if more than one key is played at once, only the lower note will be heard. The keyboard will also change from multiple- to single-triggering. This keyboard mode was popularized by the Mini-Moog monophonic synthesizer and requires--but also allows--a somewhat different keyboard technique. Instead of retriggering with each keystroke, the envelopes will only retrigger if the previous key is completely released before the new key is pressed. This requires a staccato touch. By the same token, if you play legato, the envelopes will only trigger on the first note, while the rest of the phrase will be sounded by the sustain settings of the envelopes. With practice, this system allows you to selectively accent notes by touch.

2-8 LEGATO

If UNISON is on and LEGATO is off, the keyboard operates in multi-trigger mode. If UNISON and LEGATO are on, the keyboard operates in single-trigger mode. This is also the case when the sequencer or arpeggiator is on.

2-9 GLIDE

Glide is a program parameter (#02) that affects the keyboard. Glide operates whether Unison is on (monophonic) or off (polyphonic). When programmed to 0, there is no effect: the oscillator steps instantly between specific pitches. As GLIDE is advanced, the rate at which the oscillator pitch changes is decreased. This introduces "portamento" between the notes, which can be subtle or quite extreme.

2-10 IN CASE OF DIFFICULTY

Memory

If the display counts from 1 to 6 when power is switched on, there may be a memory problem. Check your sequences and a few programs to see if they are as recorded.

If this occurs repeatedly, you may want to consult an SCI Authorized Service Center.

Control

If the keyboard or control panel "lock up," check that you are not making an operational error. If necessary, reset the computer by switching power off, then, after a few moments, back on.

If the "lock-up" occurs while using the sequencer, and you are sure that you are not making an operational error, reset the sequencer (see page 3-12).

Power

If the Six-Trak is receiving power, it will display program numbers.

If no LEDs are lit, either the Six-Trak is not switched on, power is not reaching the unit, or the fuse has blown.

Check the power source by plugging in other equipment.

Disconnect power cable and check fuse by opening fuseholder.

Examine the power cable for damage.

(see next page)

Audio

If the PROGRAM display lights but no sound can be obtained, check that MASTER VOLUME is turned up.

Check that parameter #34, VOICE VOLUME, or track volumes are not set too low.

Test the synth by simply connecting stereo headphones directly to the output.

Try substituting the audio output cable with one known to be good.

Check your amplifier by trying a high-level audio input such as another synthesizer or tape deck.

3 SEQUENCER

3-1 INTRODUCTION

The sequencer is the heart of the Six-Trak, recording the individual synthesizer timbres and tracks which result in complete orchestrations. When playing the Six-Trak live, the six voices are each programmed with the same sound (homophonic mode). Live multi-timbres are not possible because the Six-Trak cannot know which keystrokes are intended for which timbres. But the sequencer records each voice on its own track. So each voice can be overdubbed in a different program. The playback mixture of the tracks can also be programmed by individual track volume adjustment.

The sequencer capacity of 800 total notes is allotted to two "banks," SEQ A or SEQ B. (However sequence capacity can be increased to about 4000 notes through the Model 64 MIDI sequencer.)

Typically, you create multi-track sequences one track at a time. The first track recorded is referred to as the "basic" track. It determines the total length of that sequence. The basic track(s) will therefore usually be a bass or rhythm track (but can be whatever you want).

Note: As mentioned, each voice is recorded on its own track. This means, for example, that if one track is being overdubbed, only one note should be played at a time. If more than one note is played, only the last one is recorded. To record two or more voices for either the basic track or overdubbed tracks, two or more tracks need to be switched into record mode.

A previous sequence under "A" or "B" is automatically erased when a new sequence is recorded. To save them permanently, sequences can be "dumped" to the external MIDI sequencer.

3-2 PLAYBACK START/STOP

Footswitch playback instructions are on the next page. To play sequences:

Stack mode and the arpeggiator must be off. One sequence must be stopped before the other can be started. (Both SEQ LEDs must be off.)

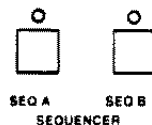

To start, press SEQ (A or B). If the sequence is empty, the LED will not light or will go off instantly.



Otherwise, the sequence will begin. SEQ lights, and lit TRACK LEDs indicate which tracks are in playback.

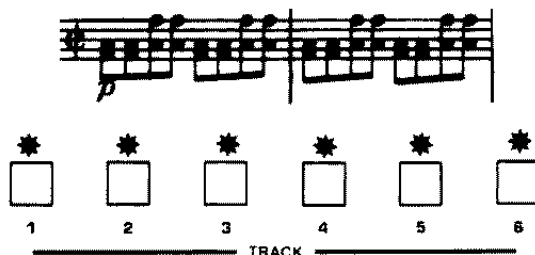

The initial playback speed of the sequence will always be the last speed at which it played.



Adjust SPEED as desired.

Note: Do not turn SPEED all the way counterclockwise, as this will stop the sequencer by selecting MIDI clock input.

The sequence will repeat continuously ("loop"), until SEQ is pressed. At the end of each loop, the TRACK LEDs will blink.

If all TRACK LEDs are lit, no voices will be available for live accompaniment. (The sequencer is using all six voices.)

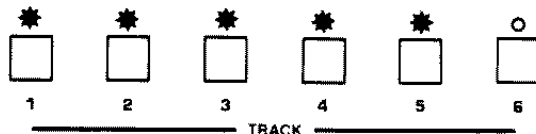

If any TRACK LED is not lit, this means at least one voice is available for live accompaniment. To play along with the sequence:

Select desired program.

Play no more keys at once than the number of available voices (non-used sequencer tracks).

Use the wheels. They will only apply to live playing, not the sequence.

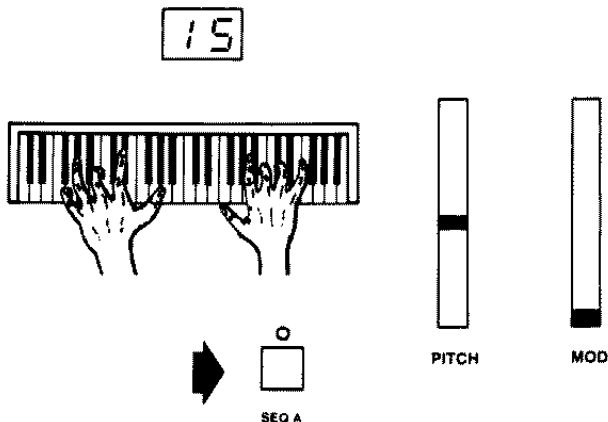

To stop sequencer, press SEQ.

3-3 OPTIONAL FOOTSWITCH START/STOP

To control sequencer playback with the footswitch:

Start playback normally, by selecting SEQ A or B.



Stop sequence by pressing footswitch.

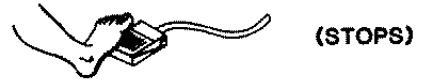

The SEQ LED will remain lit, indicating standby.



To start the sequence again, press the footswitch.



The sequence will loop until the footswitch (or SEQ) is pressed.

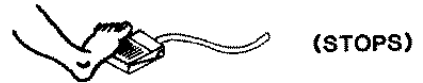

3-4 TRACK VOLUME

During playback, the mixture of the track volumes can be adjusted. This adjustment is remembered. Whenever the sequence is played, the track levels will be set as they were last adjusted.

With sequence playing back, SEQ and the TRACK LEDs of recorded tracks will light.

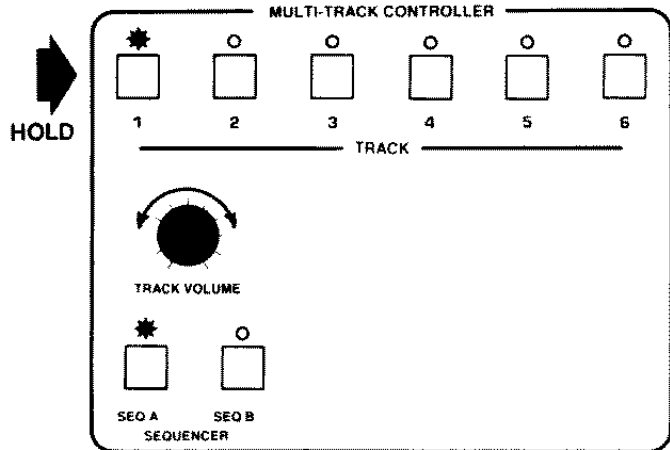

Hold desired (lit) TRACK switch.

Adjust TRACK VOLUME as desired. (It is possible to mute the track entirely.)

Release TRACK switch.

3-5 MEMORY FULL

Before recording or overdubbing, you should be aware of how "Memory Full" is indicated.

The sequencer has a capacity of about 800 notes.

When 800 notes have been recorded in both sequences, the TRACK RECORD and TRACK LEDs will start blinking rapidly. To escape this situation, switch SEQ (A or B) off. You can create more space by erasing undesired tracks in either sequence, or by erasing either sequence entirely.

If the memory full warning is ignored, excess notes will be recorded over the beginning of the current sequence, producing unpredictable results. (The other sequence is not affected.)

3-6 RECORD BASIC TRACK(S)

Check that the PITCH wheel is centered (detented).

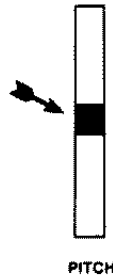

Check that the SPEED knob is centered.



SPEED

Select program desired for basic track(s).

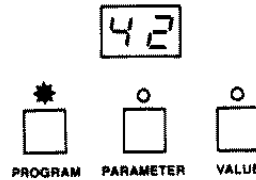

Switch TRACK RECORD on. (If you decide to not record, you can switch RECORD off, without erasing any existing sequences.)



To record, switch SEQ A or B on.
Note: This erases any previous sequences in these banks.)



TRACK 1 will light automatically.



If more than one voice is needed for the basic track, switch on additional TRACK switches (2, 3, etc.).

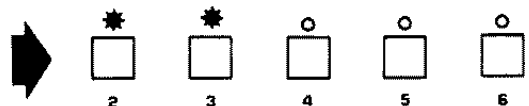

Recording will start automatically when you begin to play.

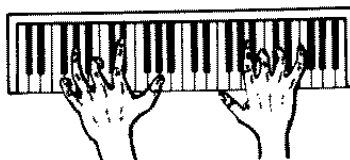

When recording starts, the selected TRACK LEDs will blink.

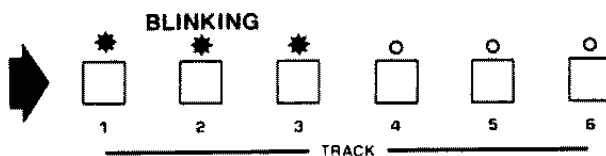

While the sequencer is recording, the PITCH and MOD wheels are locked out.



To stop recording, in time with the desired ending, either:

Switch RECORD off. The recorded basic track(s) will playback and loop. (If the playback is transposed, the PITCH wheel was not centered before recording.)

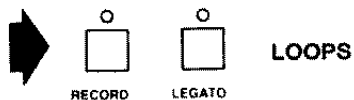

OR

or, Switch SEQ off. The sequence will not playback.



3-7 RECORDING USING THE OPTIONAL FOOTSWITCH

Switch TRACK RECORD on.



Select SEQ A or B.



TRACK 1 will light automatically.

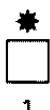

If desired, select additional tracks.

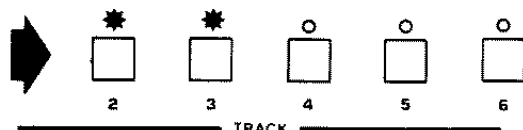

If you press the footswitch, recording will begin with a rest.



Or, recording will start automatically when you begin to play.

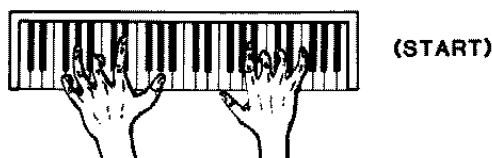

The TRACK LEDs will blink.

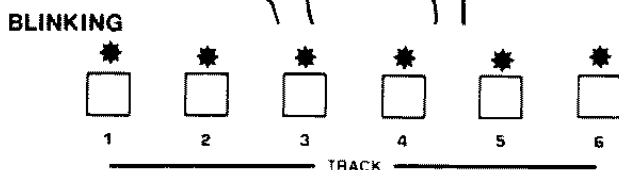

To stop recording, press the footswitch in exact time with the desired ending.



The recorded basic track(s) will playback and loop. The LEDs for tracks recorded will remain lit during playback.

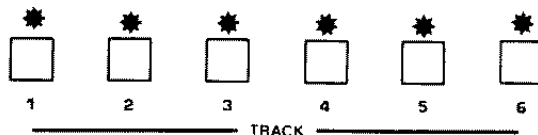

To stop playback, press the footswitch again. SEQ will remain lit.



Pressing the footswitch again will start the sequence.



3-8 BASIC OVERDUBBING

If not already playing back, start playback of basic track(s), by pressing SEQ.



While playing live, select program desired for this overdub.



Switch TRACK RECORD on. It will blink.



Switch on desired overdub tracks. These TRACK LEDs will blink, indicating the tracks are ready to record. (It is possible--but not recommended--to overdub on a track which already is recorded.)

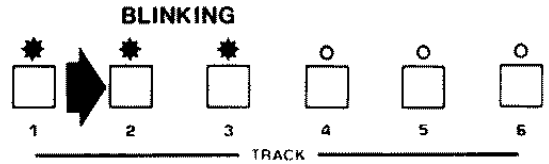

During this first loop, while both RECORD and TRACKs are blinking, anything played on the keyboard will be ignored.



(Before playing, you can switch RECORD off without affecting anything already recorded on that track. RECORD will continue to blink "ready" through this loop. Then it will go off.)

HOLD OPENING NOTES

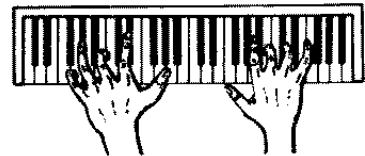

If desired, play notes intended for the first overdub beat, just before the end of this first loop. At the end, RECORD will light solidly. If any notes are being held when this occurs, they will be recorded exactly on the first beat of the sequence.



If no notes are held, during the next loop when RECORD is lit, overdubbing starts whenever you play on the keyboard.



Overdub as desired. When the end of the sequence is reached, RECORD will go off, and all recorded tracks will play back.

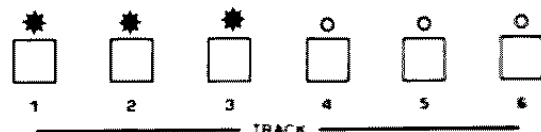

3-9 ERASING TRACKS

Start playback by pressing SEQ.

Hold TRACK RECORD. It will blink.

Press lit TRACK switch of track to be erased.

The sequence will stop and SEQ will be lit. The track is erased.

To restart, press SEQ twice, or the footswitch once.

(To erase another track, it is not necessary to restart. Tracks can be erased when the sequence has been stopped while SEQ A or B is still lit. In this case the TRACK LEDs will not be lit.)

Note: To erase an entire sequence, just re-record. Do not erase all tracks.

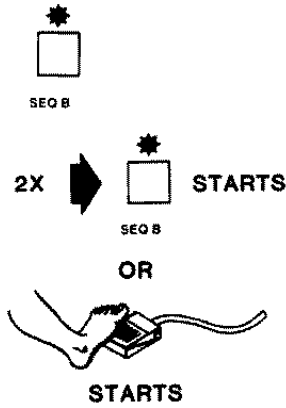
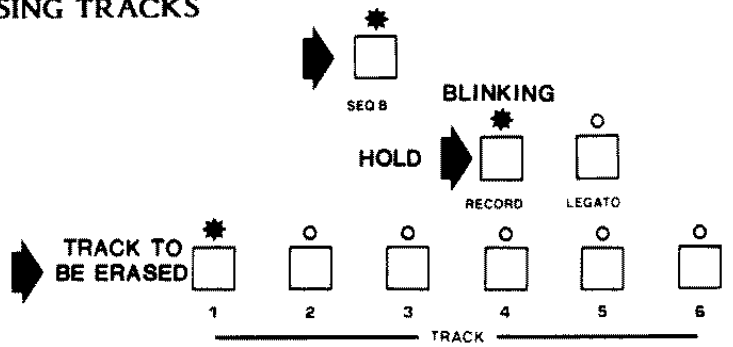

3-10 FOOTSWITCH CUE

Press SEQ to start playback.

Switch TRACK RECORD on.

Switch on desired overdub tracks.

The RECORD and TRACK LEDs will blink. (After one loop, RECORD will light solidly.)

Press footswitch. This will reset the sequence to its beginning. (You will hear nothing. The sequence is ready to start.)

Now, anything you play will automatically start overdub mode and be recorded as opening notes.

At the end of the loop, RECORD will automatically switch off.

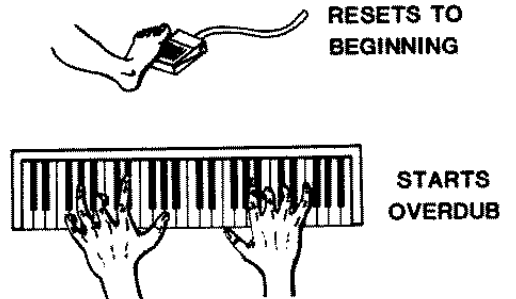
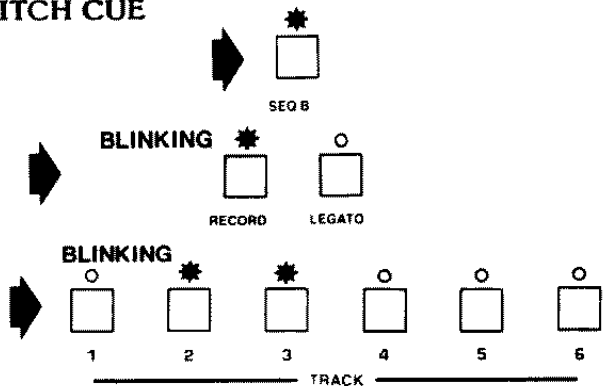

3-11 EDIT TRACK PROGRAM

To change a track's program:

Start playback by switching SEQ (A or B) on.



Switch TRACK RECORD on.



Press TRACK switches of track(s) to be reprogrammed. The LED(s) will blink.

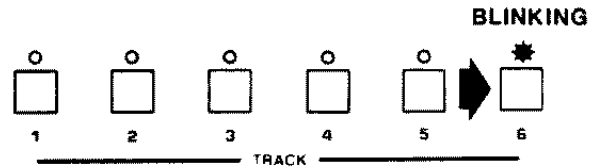

Select desired program.

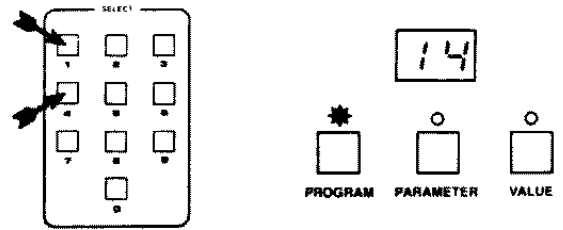

To stop, press SEQ or the footswitch.

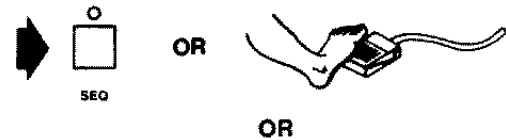

To return to normal playback without stopping, press TRACK RECORD.

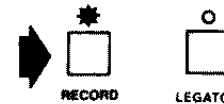

3-12 MULTI-TRACK/MULTI-TIMBRE EXAMPLE

For example, multi-track an instrumental version of a 12-bar blues:

Decide the basic arrangement for up to six voices.

For this example, we'll use voice 1 for the bass program and voices 2 - 4 for a comping organ part. This leaves two voices for thematic lines. Voice 5 will be recorded, while Voice 6 will be left for live play.

Decide the programs.

Voice/Track	Program
1	13
2	00
3	00
4	00
5	09
6	live

Check that the PITCH wheel is in center detent position.

If the wheel is not centered, the sequence will playback transposed, because the sequencer ignores the PITCH wheel during playback.

Check that the SPEED knob is approximately centered.

This gives the central control range of running speed, from approximately 1/4 to 4X real-time (recording speed). If--while recording the basic tracks--the SPEED knob is set almost fully counterclockwise (slow), then the playback rate will only be able to be increased, from 1/1 to 8X real time. If it is fully clockwise (fast), only a decrease, from 1/1 to 1/8, will be possible.

Select program for basic track.

The basic track is the first one laid down in a sequence, which establishes the basic length. It is fairly natural to lay down the bass line first, so we select that program:

PROGRAM must be on.
Select 13.

Switch TRACK RECORD on.

If you decide to not record, you can switch RECORD back off at this point, without erasing any existing sequences.

Switch SEQ A or B on.

This selection erases any sequences in these banks.
TRACK 1 will light automatically.

If more than one voice is needed for the basic track, switch on additional TRACK switches (2, 3, etc.). All selected tracks will record with the same program; however, each track program can be changed later.

If desired, start metronome for basic track. Or use Drumtraks! (See section 9.)

At this point SEQ A, RECORD, and TRACK 1 are lit.

Play the bass line.

When you play the first note, the TRACK 1 LED will start blinking, to indicate that recording has begun.

Stop recording at the right time, with RECORD or footswitch.

To record an accurate loop, press the footswitch or the RECORD switch exactly in time with the first beat of the next measure.

If you made a mistake in the bass line, just switch SEQ off, then start over.

With the basic track playing (SEQ A and TRACK 1 on), select program #00, for overdubbing the comping part.

If you want to change the pace, adjust the SPEED control.

Switch on TRACK RECORD and TRACKS 2, 3, and 4. They will all blink until the end of this first loop.

The sequencer is playing through the loop to give you time to get ready to record. If you hit the keyboard while the LEDs are blinking, nothing will be recorded. But if any keys are played or held at the end of this loop, they will automatically be recorded exactly on the first beat on the new recording loop. (This autocorrect downbeat recording only is possible on the first loop. On following loops, be sure to play overdub notes just after the start of the sequence.)

At the end of the first loop, the RECORD LED will go solid to indicate that playing will be recorded.

Again, recording does not begin until you begin to play. You can "preview" the loop as often as necessary.

Record the comping part. Play only three voices maximum.

When the sequence end is reached, RECORD will go off and all four tracks will play back.

Suppose you make a mistake on this recording.

You can erase just the track which contains the mistake, or erase all of the overdubbed parts, and re-record the whole part. What you do at this point depends on how you like to work.

Erase undesired tracks.

Hold TRACK RECORD. It will blink.
Press lit TRACK switch of track to be erased.
The sequence will stop and SEQ will be lit.
Restart and repeat for each track to be erased.

Overdub Correct Parts.

Switch to Program 09 and overdub a theme on track 5.

Select program 09.
Press SEQ A to start sequence.
Switch TRACK RECORD on.
Switch TRACK 5 on.
While RECORD blinks, hold opening note of solo.
When the next loop starts, RECORD will light solidly and recording will begin.
When the loop has finished, RECORD will go off.

Select another solo program and play, accompanied by the sequence. The wheels can be used.

3-13 IN CASE OF SEQUENCER PROBLEMS

Control

If the keyboard or control panel "lock up," check that you are not making an operational error. If necessary, reset the computer by switching power off, then, after a few moments, back on.

Sequencer

If while recording, the TRACK and TRACK RECORD LEDs start blinking rapidly, the sequencer memory is full. To escape, switch SEQ A or B off. Create more space by erasing undesired tracks.

If sequences have been lost and the sequencer is not functioning ("locked-up"), it can be reset. Be sure you are not making an operational error, because resetting will erase anything you have recorded under both sequences.

To reset the sequencer:

Hold both RECORD switches.
Press SELECT 0.

4 ARPEGGIATOR

4-1 INTRODUCTION

The arpeggiator is a very useful keyboard memory feature with two basic modes: UP/DOWN and ASSIGN. In either mode you can "latch" the arpeggiator, so it continues to play even when you remove your hands from the keyboard.

The arpeggiator uses voice 6 only. For either UP/DOWN or ASSIGN modes, the arpeggiator will recognize a maximum of sixteen held keys.

4-2 UP/DOWN

With UP/DOWN on, the Six-Trak sequences between any held keys according to their position, from low to high and back down. For example, C E G B G E C E G...

To arpeggiate:

Switch UP/DOWN on.

Hold desired keys.

The arpeggiator will play, using Voice 6.

Adjust SPEED as desired.

If only one key is held, there will be no arpeggiating. Monophonic lines can be played normally, with the arpeggiator brought in only when more than one key is held down simultaneously.

The PITCH and MOD wheels will not operate.

To latch, press the footswitch or TRACK RECORD while you hold down keys. You can then remove your hand(s) and the notes will continue to arpeggiate.

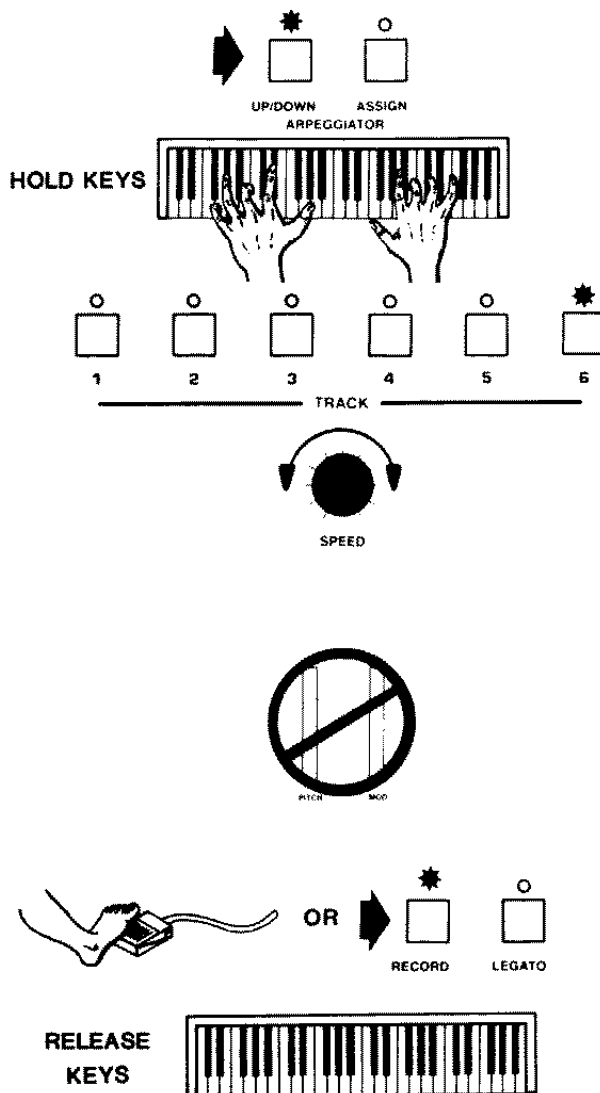

While the arpeggiator is latched, you can play along with up to five more keys, which will not be arpeggiated or latched. The wheels will operate on these live voices.

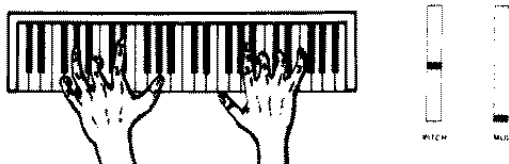

If desired, select program desired for the five play-along voices. (This can be a Unison program.)

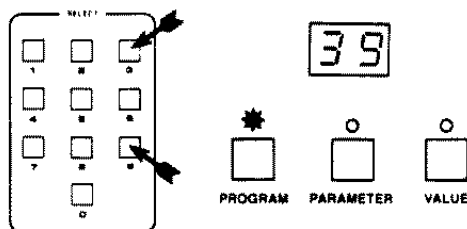

To stop, switch UP/DOWN off.

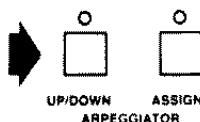

4-3 ASSIGN

ASSIGN sequences between keys according to the order they are played. For example, C G E B C G E B. This allows you to create intense riffs, without necessarily having to play them.

ASSIGN operation is the same as UP/DOWN, except you press keys in the order you want them to be played.

4-4 FOOTSWITCH NOTES

Once an arpeggiator sequence has been entered, it is possible to set up the arpeggiator to advance either by single presses of the footswitch, or in response to an external clock connected to the FOOTSWITCH jack:

Turn the SPEED knob fully counterclockwise. The arpeggiator will stop.

Tap the footswitch quickly.

Or, if desired, connect a 5-15V clock source, preferably a square wave. The maximum useful frequency will be 10 - 15 Hz. (Note that for the Six-Trak computer to recognize the clock pulse, the pulse must be at least 20 milliseconds long--both high and low. Note also that a satisfactory pulse can be obtained from the Drumtraks METRONOME OUT jack. This allows the Drumtraks to control the arpeggiator speed according to the drum pattern beat note.)

5 STACK MODE

In the Six-Trak, a stack consists of up to six different timbres (programs) assigned to one note played on the keyboard. Two separate stacks (A and B) can be created. Intervals can be stacked, usually by simply adjusting the OSCILLATOR COARSE FREQUENCY parameter (#00) for the various programs. This enables the creation of very complex sounds.

To create a stack:

Switch STACK (A or B) on.

To change the program for a voice:

- Select desired program.
- Switch TRACK RECORD on.
- Press desired TRACK switch.
- RECORD will switch itself off.
- Repeat as required to assign programs to desired voices.

To adjust voice volume:

- Hold desired TRACK switch.
- Adjust TRACK VOLUME as desired.

To delete the voice from the stack:

- Adjust voice/track volume to 0.

If LEGATO is off, the keyboard will play as in Unison mode, with multi-triggering and low-note priority. (The Unison program parameter is ignored.)

If LEGATO is on, the keyboard will play with single-triggering.

To see the program assigned to each track, simply press the desired TRACK switch. The program number for that track will be displayed.

6 PROGRAMMING THE SYNTHESIZER

6-1 INTRODUCTION

Basic operation with the factory programs has already been covered. You can use the Six-Trak solely with the factory programs. However, as good as they are, the musician is bound to feel that some are more useful than others in specific musical contexts. This is why you want to be able to create your own custom programs.

There are several aspects to programming custom sounds: knowing the Six-Trak's modes of operation and accompanying switch functions, knowing what the synthesizer parameters do in a functional sense, and knowing how to use the parameters for musical purposes.

The modes and switch functions are explained in this section. The parameters are explained in the next section. The use--the art--is your part. To exploit the Six-Trak's sonic possibilities fully, learn as much about it as you can by studying the parameters (see Section 7) and the factory programs (see Section 14). Seeing exactly how these programs are constructed will make it easier for you to begin to create your own programs. At first, practice synthesizing by editing the factory programs. For many, this will be the best way to learn exactly how the parameters on the Six-Trak operate. Then try creating programs "from scratch" (see page 6-6.)

Be advised that in the excitement of creation, new and interesting programs tend to escape if not documented. Program parameter forms are provided for this purpose following the factory program listings.

For more information, see also "Editing" in the Details section.

6-2 EDITING A PROGRAM

If they are on, switch the sequencer, arpeggiator, or stack mode off. If any of these are on, the PARAMETER switch will not light.

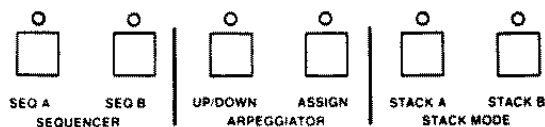

Switch PARAMETER on. PROGRAM will switch off and the current parameter number will be displayed.



Enter two digits for the parameter to be edited. (For parameter codes, see front panel.)

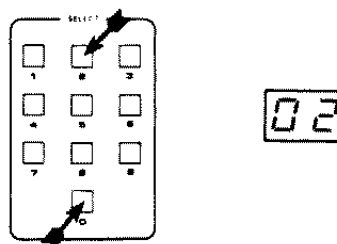

To edit the parameter value, turn the VALUE knob. (To edit, it is not necessary to switch VALUE on.)



To display the current parameter value, switch VALUE on.



6-3 RESTORING A PROGRAM

To cancel all edits and restore the original program:



Switch PROGRAM on.



Re-enter the program digits.

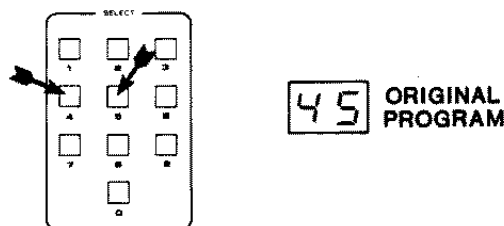

6-4 AN EDITING EXAMPLE

For example, suppose you want to change oscillator waveforms from sawtooth to pulse, change the LFO-modulation rate, and you prefer a brighter tone in the program:

Switching Waveforms

Switch **PARAMETER** on.

Enter two digits for **SAWTOOTH** parameter (10).

Switch **VALUE** on. If the sawtooth is currently on, the value will be 1.

To switch off the sawtooth, turn the **VALUE** knob counterclockwise.

The displayed value will be changed to 0, indicating the sawtooth is off.

Switch **PARAMETER** back on.

Enter 12 for **PULSE** parameter.

Switch **VALUE** on. If the pulse is off, the current value will be 0.

To switch on the pulse, turn the **VALUE** knob clockwise.

The displayed value will be changed to 1, indicating the pulse is on.

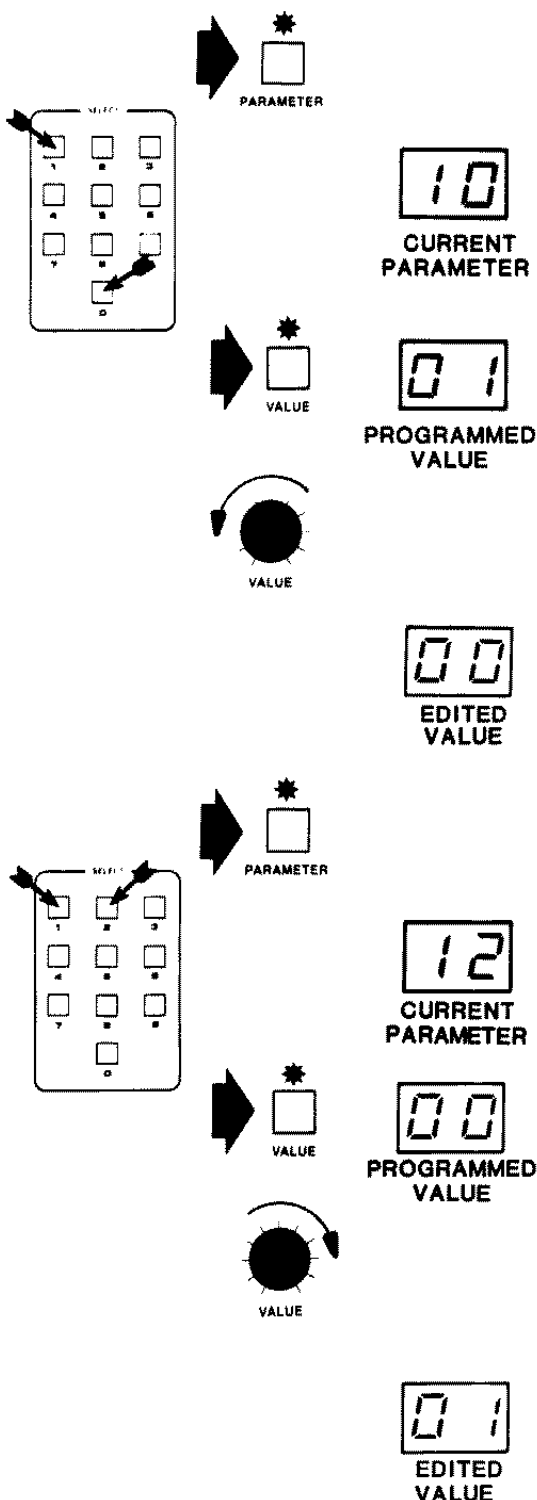

Editing Modulation Rate

Switch PARAMETER on.

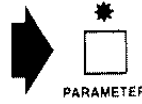

If you hit any SELECT numbers while VALUE is on, PARAMETER will be selected automatically. This feature saves time when doing extensive editing.



Enter 15 for LFO FREQUENCY.

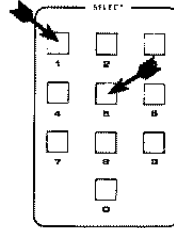

CURRENT
PARAMETER

Switch VALUE on. A number from 00 to 15 will be displayed. This is the current programmed value.

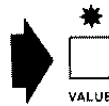

CURRENT
VALUE

While observing the display, turn the VALUE knob across its full range.

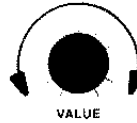

While playing, adjust the VALUE knob for desired modulation rate.



EDITED
VALUES

Editing Brightness

Enter 19 for FILTER CUTOFF FREQUENCY parameter.

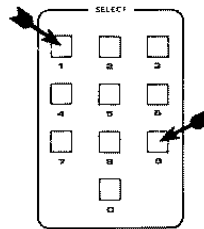

CURRENT
PARAMETER

Adjust VALUE knob for desired brightness.



The knob will work even though the VALUE switch is not on. If you want to display the cutoff value, switch VALUE on.

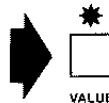

(Note that only the CUTOFF parameter has a value range from 0 to 127, and that the "1" representing hundreds is not displayed.)

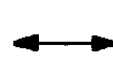

6-5 RECORDING A PROGRAM

To record an edited program or copy an existing one:

PROGRAM must be on.



CURRENT
PROGRAM

Switch CONTROL RECORD on. (Do not hold it, or you may accidentally activate "hidden functions". See Section 8.)

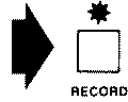

Select the first digit of the program number being recorded.

(If the original program is to be saved, use the number of an unneeded program. If the original program is to be replaced by the edited version, use that number.)

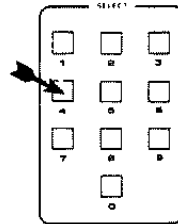

If you somehow made a mistake, you can exit record mode at this point by merely switching RECORD off. The program memory will not be affected.



Press the second digit, and the program will be recorded in that location.

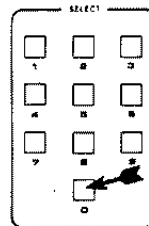

RECORDED
PROGRAM

Note: be sure to hit the correct SELECT digit or you may erase a program you wanted to keep.

When the second digit is entered, the RECORD LED will go off.



GOES OFF
AUTOMATICALLY

6-6 USING THE BASIC PATCH

When creating programs it is often convenient to begin with a basic sound instead of just editing an existing program. Starting over from a basic patch can also free you from your existing sounds to find new ones.

Rather than having to manually check and edit all of a program's parameters, a function is available which clears all parameters to 0, except for the minimum needed to produce a basic sound. To switch to this basic patch:

Hold RECORD.



Press SELECT 8.

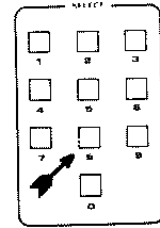

This will set all parameters to 0, except:

#10 SAWTOOTH	1 (on)
#19 CUTOFF	127
#28 FILTER KEYBOARD	2 (full)
#32 AMP SUSTAIN	15
#34 VOICE VOLUME	15

The keyboard will now play with a basic sound.

If desired, the basic patch can be recorded as a program.

Switch to other parameters and edit their values.

7 SYNTHESIZER PARAMETERS

7-1 INTRODUCTION

This section describes the Six-Trak's programmable voice parameters.

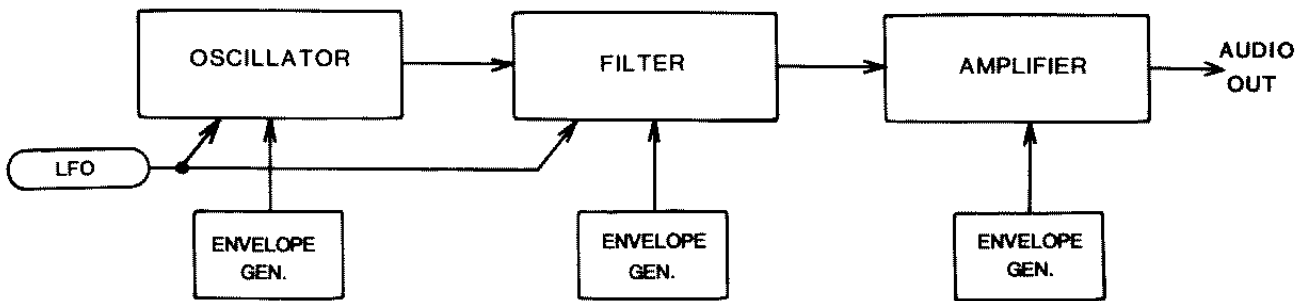

Figure 7-1
SIX-TRAK GENERAL VOICE DIAGRAM

The Six-Trak actually contains six synthesizers, termed "voices." Figure 7-1 diagrams one of these voices at a very general level. The Six-Trak fits into the tradition of voltage-controlled analog synthesizers. To understand these instruments it has proven useful to identify three basic functions: controllers, audio sources, and modifiers (filters and amplifiers). Each voice contains several of each type of function, which are represented on the block diagram, Figure 7-2.

Basically, controllers provide the control voltages (CVs) which determine the pitch of the audio sources, or the filtering or attenuation effects of the modifiers. Controllers can be mechanical devices such as keyboards and wheels. For example, as the CV from the keyboard to the oscillator (audio source) is increased, the oscillator frequency increases. Or controllers can be electronic, such as the LFO or the three envelope generators. For example, as a rapidly-decreasing CV from an envelope generator sweeps down the the filter cutoff frequency, it imparts a "pluck" to the voice. Other controllers include The MASTER TUNE knob and PITCH wheel, which in effect provide two CVs which control all of the oscillators.

There are three audio sources: the oscillator, the noise source, and the filter, if it is adjusted for self-resonance.

The mixer, filter (when not in self-resonance), and amplifier are modifiers.

A more detailed examination of the voice parameters follows. Parameter numbers are indicated by a "#."

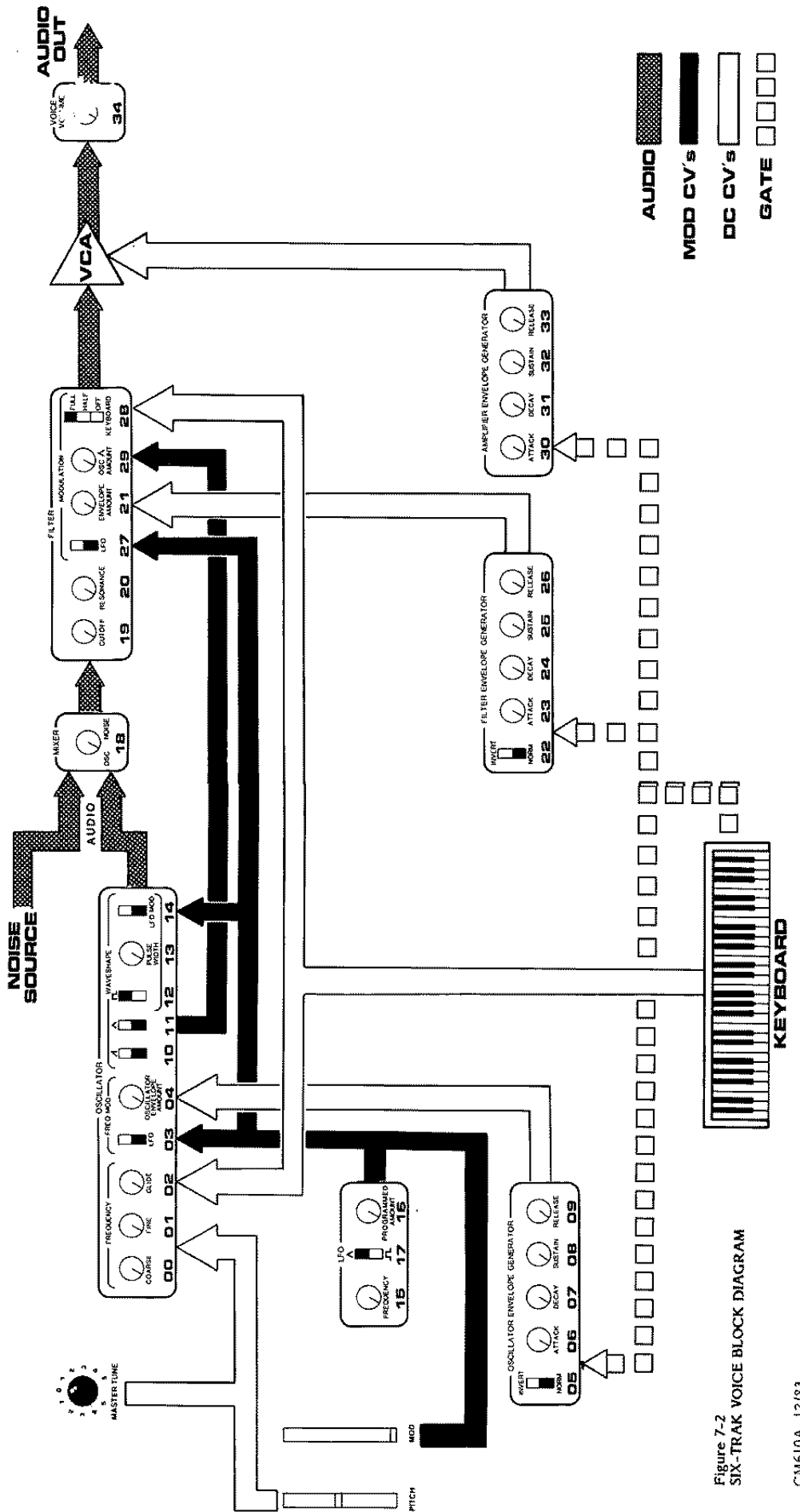

Figure 7-2
SIX-TRAK VOICE BLOCK DIAGRAM

7-2 OSCILLATOR

The oscillator is an audio-frequency source always under control of #00 COARSE and #01 FINE FREQUENCY, the keyboard, PITCH wheel, and MASTER TUNE. Oscillator frequency can be modulated by the LFO and by the envelope generator. PULSE-WIDTH (PW) can also be modulated by the LFO.

If no waveshape parameter is on, the oscillator will have no audio output. If two or three waveshapes are on, they are mixed at full level and supplied as the oscillator's output to the MIXER.

#00 COARSE FREQUENCY

Value Range: 00-48

00= lowest octave

12= one octave up

24= two octaves (middle C)

36= three octaves

48= four octaves

Adjusts oscillator pitch in semitones, over a four-octave range. To this is added the four-octave keyboard, for a total range of eight octaves.

Note that to keep programs in tune, this parameter should normally be adjusted to the octaves (00, 12, 24...).

Exact oscillator pitch should be fine-tuned with MASTER TUNE, with #01 FINE at a value of 0.

#01 FINE FREQUENCY

Value Range: 00-31

32= one semitone

Normally this parameter is set to 0, while oscillator pitch is adjusted with MASTER TUNE. This parameter adjusts oscillator frequency by up to just less than a semitone. This allows detuning of the oscillator, usually for use only in SEQUENCER or STACK modes.

#02 GLIDE RATE

Value Range: 00-15

0= no glide

15= maximum glide (four octaves in approximately ten seconds)

When set to 0, the keyboard CV, which controls the oscillator pitch, instantly steps between notes. As GLIDE is raised, the CV does not step between the notes, but begins to slide. This introduces "portamento" between notes. Usually used with #35 Unison on, because polyphonic (Unison off) use is difficult to predict--but can produce interesting effects.

#03 LFO FREQUENCY MODULATION

Value Range: 00/01

00= Off

01= On

This enables LFO modulation to the oscillator frequency, according to the level set by #16 LFO AMOUNT and the MOD wheel. This produces a vibrato or trill, according to the value of #17 LFO SHAPE.

#04 OSCILLATOR ENVELOPE AMOUNT

Value Range: 00-15

This parameter controls the depth of oscillator envelope modulation.

Each voice contains three independent ADSR envelope generators: one (#05-09) controls oscillator frequency; one (#22-26) controls filter cutoff frequency; and one (#30-33) controls the amplifier gain. The following comments on the ADSR envelope generators are valid for all three.

An "envelope" changes value over time at a rate adjusted by the ATTACK, DECAY, and RELEASE parameters. As the envelopes are generated with each keystroke, they "contour" the voice intonation, timbre, and dynamics, animating the otherwise raw waveshapes which come from the mixer.

The contour pattern is initiated when a key is struck. This "triggers" the envelope generator(s) to proceed through their attack and decay periods. These periods can each range from zero to about 11 seconds. The envelope voltage rises to its full value, then falls (decays) to the level set by the sustain parameter, where it remains until the key is released. When the key is released, the gate goes off and the envelope voltage drops to zero at a rate set by the release parameter.

#05 INVERT

Value Range: 00/01

00=Normal

01=Invert

This turns the oscillator envelope upside down. When normal, the envelope will drive the oscillator sharp. If inverted, the oscillator will be driven flat.

#06 ATTACK

Value Range: 00-15

8= 1 second

15= 11 seconds

Adjusts the length of time for the envelope to go from zero level (when key is initially depressed) to maximum level.

#07 DECAY

Value Range: 00-15
8= 1 second
15= 11 seconds

Adjusts the length of time for the envelope to go from maximum level to sustain level. If sustain is set at maximum then the decay parameter value is irrelevant, because level is already maximum.

#08 SUSTAIN

Value Range: 00-15

Adjusts the sustain level from zero to maximum. This is a level control, not a time control. Sustain time is the period between the end of the decay period and the beginning of the release period. This is the length of time the key is held after attack and decay.

#09 RELEASE

Value Range: 00-15

Adjusts the length of time for the envelope to go from sustain level to zero. If the key is released before the attack or decay periods have elapsed, release controls the time taken for the envelope to drop to zero from whatever its level when the key was released. If the attack and decay periods have elapsed and sustain is set to 0, then the release value is irrelevant, because the level is already minimum.

#10 SAWTOOTH WAVE

Value Range: 00/01
00= Off
01= On

Enables full-level waveshape containing all harmonics. This basic shape is often described as "brassy."

#11 TRIANGLE WAVE

Value Range: 00/01
00= Off
01= On

Enables full-level triangle wave, containing little harmonic energy, thus having a dull tone.

#12 PULSE WAVE

Value Range: 00/01

00= Off

01= On

Enables full-level waveshape whose harmonic content, thus timbre, depends on the value of #13 PULSE WIDTH and LFO modulation. If switching this on produces no sound, try adjusting #13 to a value between 2 and 60.

Note: If all three waveshapes are on (#10, 11, 12), and the filter is on well open (#19 and #28), some distortion may occur when several keys are played simultaneously. If this occurs, compensate by simply reducing VOICE VOLUME.

#13 PULSE WIDTH

Value Range: 00-63

01= 1%

15= 25%

31= square wave

47= 75%

63= 99%

Adjusts the harmonic content of the pulse wave by varying its duty cycle from approximately 1 to 99%. At the extreme parameter values (00-02 and 60-63) the pulses may be barely audible. A 50% duty-cycle pulse (having only odd harmonics), also called a square wave, can be selected (approximately value 31).

This parameter is only effective if #12 PULSE is on. This parameter has no effect on the sawtooth or triangle waves.

#14 PULSE-WIDTH LFO-MODULATION

Value Range: 00/01

00= Off

01= On

Applies LFO-modulation to oscillator pulse width.

7-3 LFO

"Modulation" refers to a periodic or consistent (as opposed to accidental) aural change which is interesting or musically useful. Modulation is created by electronic controllers when it is not possible to adjust a mechanical controller with the required speed or precision. Modulation systems thus free the hands for playing the keyboard.

Modulation involves a signal-generating source and a modulated destination. The Six-Trak contains two modulation systems in each voice: LFO-MOD and FREQUENCY-MOD. FREQ-MOD has one source, the oscillator, and one destination, the filter. For more information see #29 OSC TRIANGLE MODULATION AMOUNT.

LFO-MOD has a low-frequency oscillator (LFO) as a source, but has three selectable destinations. The LFO frequency, waveshape, and basic output level are adjusted by parameters #15-18. To this modulation level will be added any contribution of the MOD wheel. Total modulation is applied by LFO switches #03, 14, and 27 to three destinations.

#15 FREQUENCY

Value Range: 00-15

Adjusts LFO frequency from about ¼ to 20 Hz.

#16 PROGRAMMED AMOUNT

Value Range: 00-31

Programs modulation depth independently from the MOD wheel.

#17 TRIANGLE/SQUARE WAVE

Value Range: 00/01

00=Triangle

01=Square

Selects a triangle wave for vibrato, or a square wave for trills.

7-4 FILTER

The FILTER section contains parameters of the filter itself and of its ADSR envelope generator. The envelope generator is identical to the oscillator envelope generator, discussed above (see #04-09).

#18 OSC/NOISE MIXER

Value Range: 00-31

00= maximum oscillator level

15= even mixture

31= maximum noise level

Adjusts the ratio of the oscillator and noise source input to the filter.

#19 CUTOFF FREQUENCY

Value Range: 00-127

(The "hundreds" digit is not displayed. For example, value 127 is displayed as 27.)

Adjusts cutoff frequency of the 24 dB/octave (4-pole) low-pass filter. This parameter is rather like a tone control. "Cutoff" is the frequency below which all elements of the mixer's output signal are let through. The higher-frequency components of the input signal (that is, all those above the cutoff frequency) are suppressed. The higher the parameter value, the higher the frequencies are which pass through the filter. Thus, the "brighter" the sound.

In addition to this parameter, overall cutoff frequency is the result of all the filter modulation parameters (#21-29).

#20 RESONANCE

Value Range: 00-63

43= approximate oscillation point (may vary by voice)

Adjusts the amount of filter resonance. As the value is increased from 0, the amount of resonance ("emphasis," "regeneration," or "Q") applied to those signal components at the cutoff frequency will increase. As resonance increases, frequencies lower than the cutoff will become decreasingly audible in comparison with those nearer the cutoff. As the parameter value is increased, the filter breaks into oscillation, acting like a sine-wave audio source whose pitch is determined by #19 CUTOFF FREQUENCY (and the various filter modulation sources).

#21 ENVELOPE AMOUNT

Value Range: 00-15

00= no envelope modulation

The filter cutoff may be varied over time by the filter envelope generator. This parameter adjusts the depth of filter envelope modulation (similar to #04).

#22 INVERT

Value Range: 00/01
00=Normal
01=Invert

When normal, the envelope will drive the filter cutoff positively. If inverted, the filter cutoff contour will be reversed.

#23 ATTACK

Value Range: 00-15

Same as #06.

#24 DECAY

Value Range: 00-15

Same as #07.

#25 SUSTAIN

Value Range: 00-15

Same as #08.

#26 RELEASE

Value Range: 00-15

Same as #09.

If filter release produces no effect, check that #33 AMPLIFIER RELEASE is set to approximately the same value.

#27 LFO

Value Range: 00/01
00= Off
01= On

This parameter switches LFO-modulation to the filter, which normally produces a vibrato effect.

#28 KEYBOARD

Value Range: 00-02

00= Off

01= Half

02= Full

When Full, the KEYBOARD control voltage (CV) is applied to the filter's cutoff frequency just as it is normally applied to the oscillator. With the filter thus "tracking" the keyboard, cutoff frequency is maintained at a constant point relative to the notes being played. This results in a consistency of timbre over the whole keyboard range. When KEYBOARD is off, notes played higher on the keyboard will have a duller timbre. Obviously, the 1/2 value selects the midrange between these two effects.

If #20 FILTER RESONANCE is set for self-oscillation, setting KEYBOARD on Full will allow the filter to be played from the keyboard. However, since the filters in resonance are not precisely tuned, there will be considerable error from the normal keyboard scale. (Unless a complex effect is desired, #21 ENVELOPE AMOUNT will in this case normally be set to 0, to maintain a steady frequency from voice to voice).

If the KEYBOARD parameter is toggled while holding keys down, the effect will not be heard until the key is restruck.

#29 OSC TRIANGLE MOD AMOUNT

Value Range: 00-63

This parameter controls **FREQ-MOD**. Increasing this parameter applies the oscillator triangle waveform as a control voltage to the filter cutoff frequency. This high-frequency modulation is used to create "ring" modulation and bell effects.

This parameter operates regardless of whether #11 **OSCILLATOR TRIANGLE** is switched on.

7-5 AMPLIFIER

The sole amplifier controls are the envelope generator attack, decay, sustain, and release parameters, which shape the envelope applied to the VCA. These parameters control the note dynamics.

#30 ATTACK

Value Range: 00-15

Same as #06.

#31 DECAY

Value Range: 00-15

Same as #07.

#32 SUSTAIN

Value Range: 00-15

Same as #08. Unless this parameter is turned up slightly, nothing will be heard after the attack and decay periods have elapsed.

#33 RELEASE

Value Range: 00-15

Same as #09.

#34 VOICE VOLUME

Value Range: 00-15

15= maximum signal-to-noise ratio

Programmable voice volume is a convenient way to balance the loudness of programs so you aren't always fiddling with MASTER VOLUME. Use it after the program is basically recorded.

7-6 UNISON

#35 UNISON

Value Range: 00/01

00= Off

01= On

When off, the keyboard plays polyphonically with six voices. When on, all voices are assigned to the lowest note played. If LEGATO is off, the keyboard will be in multiple-trigger mode: every new keystroke triggers an attack/decay. If LEGATO is on, the keyboard will be in single-trigger mode; playing legato--connected--will not retrigger notes (see "Unison" under Basic Operation).

8 HIDDEN FUNCTIONS

Note: All hidden functions are performed by using the listed control switches simultaneously. While holding the RECORD switches, press the indicated SELECT switch. CONTROL RECORD is on the right. TRACK RECORD is on the left.

8-1 GENERAL

<u>Manual Tune</u>	CONTROL RECORD/SELECT 6
<u>Basic Patch</u>	CONTROL RECORD/SELECT 8
<u>Sequencer Reset</u>	Hold both RECORDs/SELECT 0 (Erases any sequences.)

8-2 MIDI

Modes

<u>Mode 1--Omni On/Mono Off</u>	TRACK RECORD/SELECT 1
<u>Mode 3--Omni Off/Mono Off</u>	TRACK RECORD/SELECT 3
<u>Mode 4--Omni Off/Mono On</u>	TRACK RECORD/SELECT 4

Dumps

<u>Dump Current Sequences and Stacks</u>	CONTROL RECORD/SELECT 0.
<u>Dump Current Program</u>	CONTROL RECORD/SELECT 2.
<u>Dump 100 Programs</u>	TRACK RECORD/SELECT 9.

Control Options

Select Double Mode TRACK RECORD/SELECT 2.
For 610/610 or 610/210. Enables wheel changes, voice-to-voice program changes and note information (Mode 4). Selects Channel 11 if set to higher. All Notes Off.

Select MIDI Clock Input Turn SPEED knob fully (counterclockwise).

Enable/Disable Program Change CONTROL RECORD/SELECT 1.
This toggles Program Change over MIDI, send and receive. On power-up, Program Change is disabled.

Enable/Disable Wheels and Parameters CONTROL RECORD/SELECT 4.
This toggles PITCH and MOD wheel send/receive and Parameter changes (receive only) over MIDI. On power-up, wheel and parameter changes are disabled.

Local On TRACK RECORD/SELECT 7.
Enables the 610's keyboard.

Local Off TRACK RECORD/SELECT 8.
Disables the keyboard. Ignored when either the sequencer, arpeggiator, or stack mode are on.

8-3 FOR SERVICE USE ONLY

CAUTION: Operators should not attempt to use these functions.

Center PITCH Wheel. CONTROL RECORD/SELECT 3.

Zero DAC CONTROL RECORD/SELECT 7

Tune Test Toggle CONTROL RECORD/SELECT 9.

9 USING THE SIX-TRAK WITH DRUMTRAKS

Connect Drumtraks MIDI OUT to Six-Trak MIDI IN.

Create a looping pattern or short drum song on Drumtraks.

Switch Six-Trak RECORD on.

Select SEQ A or B.

Start Drumtraks.

Record basic track(s) on Six-Trak, after one loop.

When basic track(s) are done, stop recording on Six-Trak in time with end of Drumtraks pattern or song.

(For convenience, stopping the Drumtraks will stop the Six-Trak as if it were stopped with its own footswitch.)

On the Six-Trak, turn SPEED knob fully counterclockwise, to select MIDI clock input from Drumtraks for playback.

To overdub more tracks, repeat this same basic process.

A second Six-Trak can be connected in series so both Six-Traks will sync to one Drumtraks:

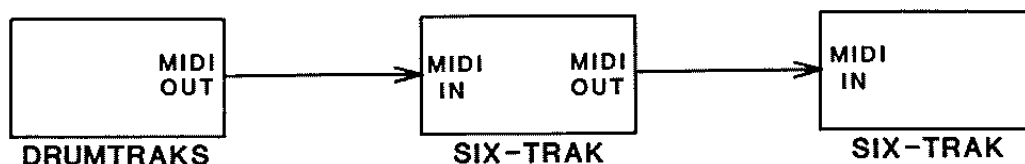

Figure 9-1

Note: If Six-Trak OUT is connected to Drumtraks IN, lowest Six-Trak keys will play certain Drumtraks instruments. (For more information, see the Drumtraks Operation Manual.)

10 USING MIDI

This section will present practical instructions on how to use the 610 with other instruments. When power is switched on, the MIDI system is set up for basic use. However, numerous control options are available for less conservative applications. For programming details, see the MIDI implementation data near the back of this manual.

10-1 CONNECTING TWO SIX-TRAKS

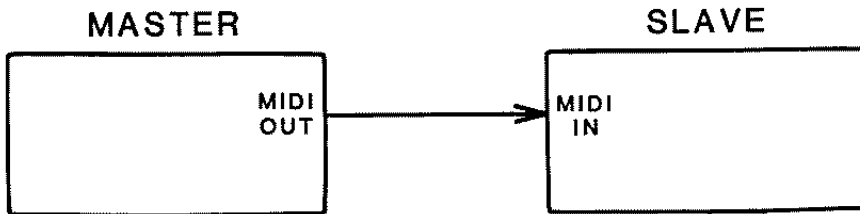

Figure 10-1
DUAL SIX TRAKS

Switch power off!

This is done to establish a common starting point.

Connection

Connect MIDI OUT of master unit to MIDI IN of the slave.
Connect AUDIO OUT of both units to monitor system.

Switch power on.

At power on, some of the features or options described below are enabled, while others are disabled.

Select usable programs on both Six-Traks.

These programs should probably not be transposed. (In other words, playing a C should produce a C.)

Check that both PITCH wheels are centered, and MODs are down.

Tune the two Six-Traks.

On the master, center MASTER TUNE and hold a key. The same key on the slave will be played (by MIDI). Adjust the slave's MASTER TUNE.

10-2 BASIC MIDI OPERATION

Keyboard playing on the master is duplicated by the slave.

On power-up, keyboard information is sent and received. As you play on the master, the same notes will be played on the slave.

Wheel changes on the master have no effect on the slave.

Program changes on the master have no effect on the slave.

You must select programs separately on the master and slave.

When the master's sequencer or arpeggiator is on, the slave will not play the sequenced or arpeggiated notes.

However, the slave will play any notes that you play on the keyboard while the sequencer is running or the arpeggiator is latched.

10-3 DUMP OPERATIONS

If you want to send a specific program from the master to the slave, on the master only, hold CONTROL RECORD and press SELECT 2. (Then, on slave, re-select program number.)

For example, on the master, program 33 is selected. You hold CONTROL RECORD and press SELECT 2. Program 33 on the slave will now have the master's program. To activate this new program, select the new 33 (on the slave).

If you want to send all 100 programs from the master to the slave, on the master only, hold TRACK RECORD (on the left) and press SELECT 9. (Then, on slave, re-select program number.)

RECORD will remain lit for a moment while the data dump occurs.

The master's programs will be copied into the slave.

The slave's current program will not change by itself. Select desired new program(s).

If you want to send the sequences and stacks from the master to the slave, on the master only, hold CONTROL RECORD and press SELECT 0.

RECORD will remain lit for a moment while the data dump occurs.

The master's sequences and stacks will be copied into the slave.

Check that the slave's SPEED knob is not set fully counterclockwise.

10-4 CONTROL OPTIONS

To select Double Mode, on both units, hold TRACK RECORD and press SELECT 2.

When this is done, the slave will become an exact double of the master. It will respond to all notes, live or sequenced, following all voice-to-voice program changes, and wheel changes.

To make the master switch the slave's programs, on both units, hold CONTROL RECORD and press SELECT 1.

Now, for example, when you select program #45 on the master, the slave will automatically switch to its program #45.

To disable program changes, repeat CONTROL RECORD/SELECT 1, on both.

To make wheel changes on the master also apply to the slave, on both units, hold CONTROL RECORD and press SELECT 4.

To disable wheel changes, repeat CONTROL RECORD/SELECT 4, on both.

To have the master sequencer play the slave, select Mode 4 on both units by holding TRACK RECORD and pressing SELECT 4.

To disable this control, select Mode 1 by TRACK RECORD/SELECT 1, on both.

If it is desired to disable the slave's keyboard and wheels, on the slave only, hold TRACK RECORD and press SELECT 8.

Don't do this when either the slave's sequencer, arpeggiator, or stack mode are on. It will be ignored.

To enable keyboard and wheels, do TRACK RECORD/SELECT 7.

Note: MIDI is an evolving system. We encourage you to experiment with various instrument configurations and let us know what, if any, other control options would be useful to you.

10-5 A SIX-TRAK AND PROPHET-T8

This paragraph gives a basic example which should be applicable to many other synthesizers.

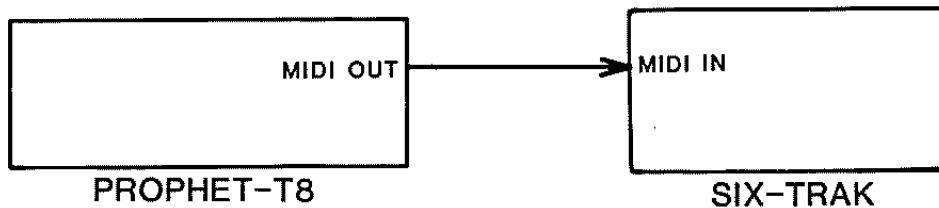

Figure 10-2
PROPHET-T8/SIX-TRAK CONNECTION

Switch power off!

Connection

Connect MIDI OUT of master unit to MIDI IN of the slave.
Connect AUDIO OUT of both units to monitor system.

Switch power on.

Select usable programs on both synthesizers.

These programs should probably not be transposed. (In other words, playing a C should produce a C.)

Check that both PITCH wheels are centered, and MODs are down.

Tune the two synths.

Tune the -T8 to its A-440 reference. Tune the Six-Trak to the -T8.

The Six-Trak is controlled by the lower five octaves (C-C) of the T-8's keyboard, including the sequencer.

This is regardless of keyboard mode (SINGLE, SPLIT, DOUBLE).

If the Six-Trak sequencer is on, the Six-Trak will still try to play the most-recently received notes from the -T8.

To enable -T8 wheel changes to control the Six-Trak, on both units, perform (CONTROL) RECORD/SELECT 4.

If, on the -T8, ENABLE WHEELS is programmed or edited to off on both sides, remote wheel control will be disabled.

To enable -T8 program changes to control the Six-Trak, on both units, perform (CONTROL) RECORD/SELECT 1.

100 of the -T8's LEFT and RIGHT programs correspond to the Six-Trak program numbers, as indicated by the following abbreviated table:

<u>-T8</u>	<u>Six-Track</u>	<u>-T8</u>	<u>Six-Track</u>
L11	00	R11	64
L12	01	R12	65
L21	08	R21	72
L31	16	R31	80
L41	24	R41	88
L51	32	R51	96
L61	40	R54	99
L71	48	R55 and up	not recognized
L81	56		
L88	63		

If you want to disable the Six-Trak's keyboard and wheels, hold TRACK RECORD and press SELECT 8.

Don't do this when either the slave's sequencer, arpeggiator, or stack mode are on. It will be ignored.

To enable keyboard and wheels, do TRACK RECORD/SELECT 7.

11 DETAILS

Arpeggiator: The arpeggiator can be advanced either by:

- The internal clock which is set by the SPEED knob.
- When latched, by the footswitch. (Set SPEED to 0.)
- By an external clock into the footswitch jack. (Set SPEED to 0.)

The arpeggiator cannot be advanced by the MIDI clock.

Editing: All PARAMETERS listed on the front panel are programmable (subject to setting by the computer), while the two wheels, for example, are non-programmable. Generally, the programmable parameters are crucial to establishing the characteristic sound of a program, while the non-programmable wheels are for performance. However, this does not mean that the programmable parameters are unalterable.

Except when the sequencer, arpeggiator, or stack mode is on, the programmable parameters can be altered at any time and each alteration will influence the sound. Adjusting the programmable parameters is called editing.

Edit Mode is a powerful tool that allows you to experiment with program changes by selectively adjusting each front panel parameter. The original program remains unchanged and can be restored at any time. Edited programs can be recorded into the original location if the original program is not desired, or into a program location which contains an undesired program.

Edit Mode is entered when PARAMETER is switched on. The current parameter number will be displayed and can be changed. When the VALUE knob is turned, the parameter will be adjusted. (To edit the current parameter, VALUE does not have to be switched on.) To check the current parameter value, switch VALUE on.

Footswitch: In STACK MODE, the footswitch is ignored.

Glide: Because the six voices are assigned to each new note in rotation, polyphonic glide (Unison off) is not easy to predict. The amount of voice glide is the difference between the last and next note to which it is assigned. For example, if GLIDE is turned up and all voices have been assigned to the bottom of the keyboard (by virtue of six different low notes having been played there), and you then play notes each in the middle and high ranges, the middle notes will "arrive" before the higher notes.

Homophony: Same-sounding. When the sequencer or stack mode isn't on, the Six-Trak voices are homophonic.

Low-note priority: When parameter #35 UNISON is on, all voices are assigned to one key. When two keys are pressed, only the lower note is voiced.

Polyphonic: Many-voiced. Applied to the Six-Trak, this means that up to six different notes can be played simultaneously. The Six-Trak is polyphonic unless #35 UNISON is on.

Program: A program is the set of all parameter values which create a specific sound.

RECORD: There are two RECORD switches. On the left is TRACK RECORD, for the sequencer, arpeggiator, and stack functions. On the right is PROGRAM RECORD, for recording and copying programs.

Value: Parameter value can only be adjusted when PARAMETER or VALUE is on.

Wheels, PITCH/MOD: The wheels do not operate on sequence tracks, nor upon voice 6 when it is being played by the arpeggiator.

The PITCH and MOD wheels to the left of the keyboard are performance tools which may take some practice to master. The wheels are monophonic. That is, both wheels affect all voices uniformly: all voices are pitch-bent by the same interval and modulated to the same depth. An integral part of playing is using the wheels for expression through pitch and timbral variations.

The PITCH wheel is normally left in its center-detent position, from which it is possible to "bend" oscillator pitch up or down by about a 3rd.

The MOD wheel sets the modulation level, in addition to the programmed LFO AMOUNT (parameter #16). When not in use the wheel is left "down" and no modulation will occur. When the wheel is advanced fully "up," modulation is maximum.

12 MODEL 610 SIX-TRAK SPECIFICATIONS

General Description

Six-voice multi-timbral hybrid analog synthesizer with six-track sequencer.
Homophonic capability.
Four-octave keyboard.
Non-volatile memory (backup battery).
100 user-programmable instrument programs

Synthesizer Functions

Preset mode
Program edit and record
Displays program number, parameter number,
and parameter value
One knob adjusts parameter values
Legato
Autotuning
Pitch wheel
Modulation wheel
Master Volume
Master Tune
Copy Program

Program Parameters

SYNTHESIZER PARAMETERS

OSCILLATOR

00 COARSE FREQUENCY
01 FINE FREQUENCY
02 GLIDE RATE
03 LFO
04 ENVELOPE AMOUNT
05 INVERT
06 ATTACK
07 DECAY
08 SUSTAIN
09 RELEASE
10 SAWTOOTH WAVE
11 TRIANGLE WAVE
12 PULSE WAVE
13 PULSE WIDTH
14 LFO

LFO

15 FREQUENCY
16 PROGRAMMED AMOUNT
17 TRIANGLE/SQUARE WAVE

FILTER

18 OSC/NOISE MIXER
19 CUTOFF FREQUENCY
20 RESONANCE
21 ENVELOPE AMOUNT
22 INVERT
23 ATTACK
24 DECAY
25 SUSTAIN

- 26 RELEASE
- 27 LFO
- 28 KEYBOARD
- 29 OSC TRIANGLE MOD AMOUNT
- AMPLIFIER
- 30 ATTACK
- 31 DECAY
- 32 SUSTAIN
- 33 RELEASE
- 34 VOICE VOLUME
- UNISON
- 35 UNISON

Controller Functions

- Stack mode
- Arpeggiator Modes Up/Down, Assign, Latch
- Two sequences (SEQ A, SEQ B)

Sequencer Functions

- Capacity 800 notes
- Six tracks, one per voice
- Variable playback speed
- Record Basic Track(s)
- Play
- Overdub
- Erase Track
- Edit Track Program
- Program Track Volume
- Memory full warning

Inputs

- Footswitch ¼-inch phone TS. Starts and stops recording and playback
- MIDI 5-pin DIN

Outputs

- Audio ¼-inch phone TRS. Can drive stereo headphones.
- MIDI 5-pin DIN

MIDI Functions

- External program storage
- External sequence storage (4000 notes with SCI Model 64)
- Sequence synchronization to MIDI clock
- Alternate keyboard modes

Other

- 1 year warranty
- Power 110-125V or 220-240V
- Dimensions
 - Height 4-½ in.
 - Width 28 in.
 - Depth 12 in.
- Weight 17.5 lbs

610 SIX-TRAK MIDI IMPLEMENTATION

December 28, 1983

Unless otherwise specified, status/data bytes are given in binary, while numbers in descriptions are in decimal.

TRANSMITTED DATA

<u>Status</u>	<u>Second</u>	<u>Third/Other</u>	<u>Description/Notes</u>
---------------	---------------	--------------------	--------------------------

ROUTINE

9NH 1001 nnnn	K 0kkk kkkk K = 36(C0) - 84(C4)	40H 0100 0000	Note On.
------------------	---------------------------------------	------------------	-----------------

9NH 1001 nnnn	K 0kkk kkkk	00H 0000 0000	Note Off.
------------------	----------------	------------------	------------------

F8H 1111 1000	--	--	Timing Clock. Sent whenever a timing clock status byte (F8H) is received.
------------------	----	----	---

FCH 1111 1100			Stop Song Sent whenever a Stop Song status byte (FCH) is received.
------------------	--	--	--

CONTROL

BNH 1011 nnnn	01H 0000 0001	M 000m mmmm	Mod Wheel Amount. Only sent when enabled. Wheel values are only sent when a change of position is detected.
------------------	------------------	----------------	--

CNH 1100 nnnn	P 0ppp pppp P = 00 - 99		Program Change. From front panel. Only sent if enabled (see page 9).
------------------	-------------------------------	--	--

ENH 1110 nnnn	VI 0vvv vvvv LS byte	Vm 0vvv vvvv MS byte	Pitch Wheel Change. Wheel Center: LS = 0, MS = 64 Only sent if enabled.
------------------	----------------------------	----------------------------	--

TRANSMITTED DATA

Status Second Third/Other Description/Notes

SYSTEM EXCLUSIVE

F0H	01H	N5H	P	D	F7H	
1111 0000	0000 0001	nnnn 0101	0ppp pppp	data	1111 0111	Program Data.
(SYS EX	SCI ID	610 ID	Program #		EOX)	
			(00-99)			

Sent by request only. Data is 16 bytes of program data, sent as 32 four-bit nibbles, right justified, LS nibble sent first.

For bit packing positions, see Table 1.

If P=127, SEQ A and B, and STACK A and B are transmitted.

F0H	01H	7BH	0NH	F7H	Double Mode
1111 0000	0000 0001	0111 1011	0000 nnnn	1111 0111	
SYS EX	SCI ID	SEL CH	channel#	EOX	

Set Basic Channel to new channel N (nnnn). Also enables wheels, program change, and parameter change send/receives and selects Mode 4 (Onmi Off/Mono On). Sent with TRACK RECORD/2.

F0H	01H	7FH	F7H	Pattern Marker.
1111 0000	0000 0001	0111 1111	1111 0111	

Sent whenever a pattern marker sequence is received.

RECOGNIZED RECEIVE DATA

<u>Status</u>	<u>Second</u>	<u>Third/Other</u>	<u>Description/Notes</u>
<u>ROUTINE</u>			
8NH 1000 nnnn	K 0kkk kkkk	V 0vvv vvvv V is ignored	Note Off. The status bytes need not be sent every event.
9NH 1001 nnnn	K 0kkk kkkk	V 0vvv vvvv V ignored, except V = 0, Note Off	Note On. If K is outside of the range 36-96, it will be transposed to the nearest octave inside this range.
CNH 1100 nnnn	P 0ppp pppp P = 0 - 99, program number		Program Change. If enabled and with Omni Mode On, changes all six voices to program P (ignore channel number).
ENH 1110 nnnn	Vls 0vvv vvvv V = LS byte	Vms 0vvv vvvv V = MS byte	Pitch Wheel Change. (if enabled) Goes to all 6 voices. For reference, bit 12 = one semitone in the 610. Successive Pitch Wheel changes can be received without repeating the Status byte.
F8H 1111 1000			Timing Clock. Can be received at any time, including between any other message. Used to sync internal sequencer to Model 400 Drumtraks. <u>Note:</u> During record the 610 senses Timing Clocks from the 400 automatically, between the time RECORD is selected and when the first note is played. During playback the MIDI clock is enabled by setting the SPEED knob to zero.
FCH 1111 1100			Stop Song If sequence A or B is active, receiving this code will act like the footswitch was pressed.

RECOGNIZED RECEIVE DATA

<u>Status</u>	<u>Second</u>	<u>Third/Other</u>	<u>Description/Notes</u>
<u>CONTROL</u>			
BNH 1011 nnnn	C 0ccc cccc C = Parameter #	V 0vvv vvvv V = Parameter Value	Parameter Change (if enabled). For valid parameter numbers and values, see Table 2.
BNH 1011 nnnn	01H 0000 0001	M 000m mmmm	External Modulation Amount (if enabled). Goes to all 6 voices. This amount added to MOD wheel and programmed initial modulation amount. Successive Mod Wheel changes can be received without repeating the Status byte.
BNH 1011 nnnn	7AH 0111 1010	00H 0000 0000	Select Local Control Off. When Local Control is Off, the keyboard, wheel, and program change information is only sent over MIDI and the six voices are only controlled by MIDI. This enables elaborate keyboard modes via external controllers. Also selects parameter mode. This should not be sent to the 610 when its sequencer, arpeggiator or stack mode is on. It will be ignored.
BNH 1011 nnnn	7AH 0111 1010	7FH 0111 1111	Select Local Control On. When Local Control is On (normal), the 610's keyboard, wheels, and program changes will directly play and assign the six voices.
BNH 1011 nnnn	7BH 0111 1011	00H 0000 0000	All Notes Off.
BNH 1011 nnnn	7CH 0111 1100	00H 0000 0000	Omni Mode Off, All Notes Off. (Mode 3)
BNH 1011 nnnn	7DH 0111 1101	00H 0000 0000	Omni Mode On, All Notes Off. (Mode 1)

RECOGNIZED RECEIVE DATA

<u>Status</u>	<u>Second</u>	<u>Third/Other</u>	<u>Description/Notes</u>
BNH 1011 nnnn	7EH 0111 1110	00H 0000 0000	Mono Mode On/Poly Mode Off, All Notes Off. (Mode 4)
BNH 1011 nnnn	7FH 0111 1111	00H 0000 0000	Poly Mode On/Mono Mode Off, All Notes Off. (Mode 3)

RECOGNIZED RECEIVE DATA

<u>Status</u>	<u>Second</u>	<u>Third/Other</u>	<u>Description/Notes</u>
<u>SYSTEM EXCLUSIVE</u>			
F0H 1111 0000 (SYS EX	01H 0000 0001 SCI ID	00H 0000 0000 REQUEST Program #	F7H 1111 0111 EOX) Program Dump Request. Initiates Program Dump. If ID wrong, message ignored. P = 0 - 99 If P=127, SEQ A and B, STACK A and B.

F0H 1111 0000 (SYS EX	01H 0000 0001 SCI ID	05H 0000 0101 610 ID Program # 00-99	F7H 1111 0111 EOX) Program Dump Receive.
-----------------------------	----------------------------	--	---

If either ID wrong, message ignored.

If P=127, SEQ A and B, STACK A and B.

Sent by request only. Data is 16 bytes of program data, sent as 32 four-bit nibbles, right justified, LS nibble sent first.

For bit packing positions, see Table 1 (page 10).

F0H 1111 0000 SYS EX	01H 0000 0001 SCI ID	7BH 0111 1011 SEL CH	0NH 0000 nnnn channel#	F7H 1111 0111 EOX	Select Double Mode
----------------------------	----------------------------	----------------------------	------------------------------	-------------------------	---------------------------

Set Basic Channel to new channel N (nnnn). Also enables wheels, program change, and parameter change send/receives and selects Mode 4 (Onmi Off/Mono On).

F0H 1111 0000 SYS EX	01H 0000 0001 SCI ID	7CH 0111 1100 ENABLE	0NH 0000 nnnn voice#	F7H 1111 0111 EOX	Wheel Enable
----------------------------	----------------------------	----------------------------	----------------------------	-------------------------	---------------------

If Mode 4, enables wheels on voice N (nnnn).

F0H 1111 0000 SYS EX	01H 0000 0001 SCI ID	7DH 0111 1101 DISABLE	0NH 0000 nnnn voice#	F7H 1111 0111 EOX	Wheel Disable
----------------------------	----------------------------	-----------------------------	----------------------------	-------------------------	----------------------

If Mode 4, disables wheels on voice N (nnnn).

RECOGNIZED RECEIVE DATA

<u>Status</u>	<u>Second</u>	<u>Third/Other</u>	<u>Description/Notes</u>
F0H 1111 0000 (SYS EX	01H 0000 0001 SCI ID	7EH 0111 1110 ENABLE	F7H 1111 0111 EOX)
			Enable All MIDI Send/Receives. This forces all send/receives to be enabled, including wheels, program changes, and parameter changes.
F0H 1111 0000 (SYS EX	01H 0000 0001 SCI ID	7FH 0111 1111 PM	F7H 1111 0111 EOX)
			Pattern Marker. Sent by Drumtraks immediately after the first Timing Clock of each pattern, except at the start, when it is not sent. The 610 uses this marker during sequence recording to auto-correct the start and stop timing of the sequence.

MODE NOTES

The 610 powers-up in Omni Mode (Mode 1). The Channel Number can be changed from the front panel (see Parameter #36, under CODED FUNCTIONS). The Channel Number is ignored while in Omni On Mode, except for the Omni Off command. Mono On commands are ignored in Omni On mode (i.e., Mode 2 is not recognized). On power-up, only Note On/Off and Program Dump messages are sent and received. Wheel changes and program changes can be enabled from the front panel (see CODED FUNCTIONS).

When Omni Off is selected (Mode 3), all messages without the Basic Channel number are ignored.

When Omni Off and Mono On (Mode 4), the 610 will assign one each of its six voices to channels N to N+5, where N is the current basic channel. Note that this will normally mean channels 3 - 8 (n = 2 - 7). Note also that the basic channel must not be set above 11, to allow room for six voices. When Mode 4 is selected, it will automatically be set to 11 if the channel is higher.

If Omni On is selected while Mono is On, Poly On/Mono Off will automatically be executed.

Basic Channel number can be changed by selecting PARAMETER #36, and adjusting for a value for 1 - 16. The channel number is non-volatile--it will remain as selected even through power off. The Basic Channel is set to 3 at the factory.

Note that the Basic Channel number is sent with transmitted data.

CODED MIDI FUNCTIONS

While holding the RECORD switches, press the indicated SELECT switch. CONTROL RECORD is on the right. TRACK RECORD is on the left.

Modes

Mode 1--Omni On/Mono Off
TRACK RECORD/SELECT 1

Mode 3--Omni Off/Mono Off
TRACK RECORD/SELECT 3

Mode 4--Omni Off/Mono On
TRACK RECORD/SELECT 4

Dumps

Dump Current Sequences and Stacks
CONTROL RECORD/SELECT 0.

Dump Current Program
CONTROL RECORD/SELECT 2.

This sends 16 bytes of the program data of the program currently displayed.

Dump 100 Programs
TRACK RECORD/SELECT 9.

Control Options

Change Channel #
Select PARAMETER #36. Switch VALUE on and adjust VALUE knob to select desired channel (1 - 16). Note that in Mode 4, channel 11 is the maximum usable channel. Channel number can also be changed remotely by a Select Double Mode command over MIDI.

Select Double Mode
TRACK RECORD/SELECT 2.

For 610/610 or 610/210. In the master instrument, enables wheel changes, voice-to-voice program changes and note information (Mode 4). Selects Channel 11 if set to higher. Sends SYS EX 7B Double Mode Command to slave, to effect similar changes.

Select MIDI Clock Input
Turn SPEED knob fully counterclockwise.

Enable/Disable Program Change
CONTROL RECORD/SELECT 1.

This toggles Program Change over MIDI, send and receive. On power-up, Program Change is disabled.

Enable/Disable Wheels and Parameter Changes
CONTROL RECORD/SELECT 4.

This toggles PITCH and MOD wheel send/receive and Parameter changes (receive only) over MIDI. On power-up, disabled.

Local On
TRACK RECORD/SELECT 7.

Enables the 610's keyboard, switches, and wheels. Enabled on power-up.

Local Off
TRACK RECORD/SELECT 8.

Disconnects the keyboard, wheels, and switches from the sound-generating circuitry. The information will be sent over MIDI, but only MIDI received data will play the 610. This code will be ignored when the sequencer, arpeggiator, or stack mode is on.

Table 1
610 SIX-TRAK PROGRAM BIT MAP

16 bytes of program data

BYTE	MS BIT					LS BIT			
	B1	B0	A5	A4	A3	A2	A1	A0	
0	D0	C3	C2	C1	C0	B4	B3	B2	
1	F0	E3	E2	E1	E0	D3	D2	D1	
2	H0	G3	G2	G1	G0	F3	F2	F1	
3	I4	I3	I2	I1	I0	H3	H2	H1	
4	K2	K1	K0	J3	J2	J1	J0	I5	
5	M0	L4	L3	L2	L1	L0	K4	K3	
6	N1	N0	M6	M5	M4	M3	M2	M1	
7	O3	O2	O1	O0	N5	N4	N3	N2	
8	Q3	Q2	Q1	Q0	P3	P2	P1	P0	
9	S3	S2	S1	S0	R3	R2	R1	R0	
A	U1	U0	T5	T4	T3	T2	T1	T0	
B	W1	W0	V3	V2	V1	V0	U3	U2	
C	Y1	Y0	X3	X2	X1	X0	W3	W2	
D	Z5	Z4	Z3	Z2	Z1	Z0	Y3	Y2	
E	-	-	ZB	ZA	Z9	Z8	Z7	Z6	

POT BITS/RESOLUTION

- A= OSC FREQ/6
- B= FINE/5
- C= GLIDE/4
- D= OSC ENV AMOUNT/4
- E= OSC ENV ATTACK/4
- F= OSC ENV DECAY/4
- G= OSC ENV SUSTAIN/4
- H= OSC ENV RELEASE/4
- I= PULSE WIDTH/6
- J= LFO FREQ/4
- K= LFO AMOUNT/5
- L= MIXER/5
- M= FILTER CUTOFF/7
- N= RESONANCE/6
- O= FIL ENV AMT/4
- P= FIL ENV ATTACK/4
- Q= FIL ENV DECAY/4
- R= FIL ENV SUSTAIN/4
- S= FIL ENV RELEASE/4
- T= OSC TRI AMOUNT/6
- U= VOICE VOLUME/4
- V= AMP ENV ATTACK/4
- W= AMP ENV DECAY/4
- X= AMP ENV SUSTAIN/4
- Y= AMP ENV RELEASE/4

SWITCH BITS

Z0	OSC SAW	Z6	LFO SHAPE (1= TRI)
Z1	OSC TRI	Z7	LFO OSC
Z2	OSC PULSE	Z8	LFO PULSE
Z3	OSC ENV INVERT	Z9	LFO FILTER
Z4	FIL ENV INVERT	ZA	FIL HALF (Only one of
Z5	UNISON	ZB	FIL FULL these can be on.)

Table 2
610 PARAMETER TABLE
 (MS bytes only sent)

#	Function	# of Bits	Maximum	
		Resolution	Value	Format
1	MOD WHEEL	5	31	x00m mmmm
Mod Wheel data is right-justified in the least-significant five bits of a seven-bit number.				
All remaining data is left-justified to the correct number of digits of a seven-bit number (value 0 - 127), as shown.				
2	OSC COARSE FREQUENCY	6	48	0FFF FFFx
3	OSC FINE FREQUENCY	5	31	0fff ffx
4	OSC GLIDE RATE	4	15	0ggg gxxx
5	OSC LFO	1 (off/on)	1	0Lxx xxxx
6	OSC ENVELOPE AMOUNT	4	15	0aaa axxx
7	OSC ENV INVERT	1	1	0ixx xxxx
8	OSC ENV ATTACK	4	15	0aaa axxx
9	OSC ENV DECAY	4	15	0ddd dxxx
10	OSC ENV SUSTAIN	4	15	0sss sxxx
11	OSC ENV RELEASE	4	15	0rrr rxxx
12	OSC SAWTOOTH WAVE	1	1	0sxx xxxx
13	OSC TRIANGLE WAVE	1	1	0txx xxxx
14	OSC PULSE WAVE	1	1	0pxx xxxx
15	OSC PULSE WIDTH	6	63	0ppp pppx
16	OSC PULSE LFO-MOD	1	1	0Lxx xxxx
17	LFO FREQUENCY	4	15	0FFF Fxxx
18	LFO PROG AMOUNT	5	31	0aaa aaxx
19	LFO TRI/SQUARE WAVE	1	1	0wxx xxxx
20	OSC/NOISE MIXER	5	31	0mmmm mmxx
21	FILT CUTOFF FREQUENCY	7	127	0FFF FFFF
22	FILT RESONANCE	6	63	0rrr rrrx
23	FILT ENVELOPE AMOUNT	4	15	0aaa axxx
24	FILT ENV INVERT	1	1	0ixx xxxx
25	FILT ENV ATTACK	4	15	0aaa axxx
26	FILT ENV DECAY	4	15	0ddd dxxx
27	FILT ENV SUSTAIN	4	15	0sss sxxx
28	FILT ENV RELEASE	4	15	0rrr rxxx
29	FILT LFO-MOD	1	1	0Lxx xxxx
30	FILT KEYBOARD AMOUNT	2 (off/half/on)	2	0kkx xxxx
31	FILT-OSC TRI MOD AMT	6	63	0rrr rrrx
32	AMP ATTACK	4	15	0aaa axxx
33	AMP DECAY	4	15	0ddd dxxx
34	AMP SUSTAIN	4	15	0sss sxxx
35	AMP RELEASE	4	15	0rrr rxxx
36	VOICE VOLUME	4	15	0vvv vxxx
37	UNISON	1	1	0uxx xxxx

14 Factory Programs

The Six-Trak is shipped "ready-to-play," with 100 factory programs. These present a wide range of instrumental and sound effects. Most were programmed by SCI's Product Specialist, John Bowen, with some contributions from the SCI staff.

On the following two pages the programs are listed by number. Following that are lists of the parameter values for each factory program. Use these values for guidance in creating your custom programs.

As you invest time in custom programs, back them up through storage to an external MIDI sequencer. (For more information, see the sections on MIDI use).

FACTORY PROGRAM LIST

- | | | | |
|----|-------------------------------|----|--------------------------|
| 00 | Percussive Organ 1 | 50 | Percussive Organ 3 |
| 01 | Brass 1 | 51 | Grok brass |
| 02 | String 1 | 52 | Marlboro Strings |
| 03 | Synth with Resonance 1 | 53 | George Frederick |
| 04 | Piano 1 | 54 | Jan 2 - unison |
| 05 | Ariel | 55 | Full synth |
| 06 | Vocalings | 56 | Twang |
| 07 | Plucky 1 | 57 | Clavet |
| 08 | Son of Org - unison | 58 | Bezmod |
| 09 | Miridium | 59 | Plucky 2 |
| 10 | Percussive Organ 2 | 60 | Pleides |
| 11 | Brass 3 | 61 | Synth with Resonance 3 |
| 12 | Strings 2 | 62 | String with Filter sweep |
| 13 | Synth with Resonance 2 | 63 | Echo |
| 14 | Synth-clav | 64 | Synth B |
| 15 | Cut-bass | 65 | Hose Pose |
| 16 | Lead 1 with release | 66 | Powerpack |
| 17 | Polyglide | 67 | Lead 2 - unison |
| 18 | Res-bass | 68 | Pulse-width mod 1 |
| 19 | Loris 1 | 69 | Flute |
| 20 | Organ Flutes | 70 | High Organ Flutes |
| 21 | Slow attack brass | 71 | Digi-Horn |
| 22 | Strings 3 | 72 | Angelic |
| 23 | Release Filter | 73 | Flutey Pose |
| 24 | Piano 2 | 74 | Pulse-width mod 2 |
| 25 | Synth A | 75 | Harpsichord |
| 26 | Muted Clav-type | 76 | Synth with resonance 4 |
| 27 | Sustained lead sound - unison | 77 | Acoustic Piano - part 1 |
| 28 | Synthbass 1 - unison | 78 | Celestial |
| 29 | Harp | 79 | Golliwog Jr. |
| 30 | Donald Duck organ | 80 | Electronic Percussion |
| 31 | Cornet | 81 | Meow |
| 32 | Strings (brugel) 4 | 82 | Wind |
| 33 | High Josef | 83 | Inverted Clangorous |
| 34 | Electric Piano | 84 | Musical Orgs |
| 35 | Obiechords | 85 | UFO |
| 36 | Clav-like w/ slight release | 86 | Square wave spacey |
| 37 | Synthbass 2 - unison | 87 | SFX 1 |
| 38 | Synthbass detuned - unison | 88 | Acoustic Piano - part 2 |
| 39 | Inverted pluck | 89 | Chirp-dive |
| 40 | Unison organ. | 90 | Puce |
| 41 | Brassy vibrato | 91 | Thudmon |
| 42 | String swell | 92 | Percussive noise |
| 43 | Seraphim | 93 | Ascending release |
| 44 | Jan 1 | 94 | 4ths drop with release |
| 45 | Pennywhistle | 95 | Josef's Cousin |
| 46 | Loris 2 | 96 | Percussive wind - unison |
| 47 | Lucky Man | 97 | Percussion 3 - unison |
| 48 | Cut-bass 2 - unison | 98 | Alien - unison |
| 49 | Clav 3 | 99 | Alien wind - unison |

FACTORY PROGRAM #:	00	01	02	03	04	05
NAME:	Permissive Organ 1	Piano 1	String 1	String with Resonance 1	Piano 1	Arp 1
MOD-WHEEL:						
NOTES:						
PARAMETERS	VALUE	VALUE	VALUE	VALUE	VALUE	VALUE
(Values are 00 unless otherwise noted)						
OSCILLATOR						
00	COARSE FREQUENCY	12	24	12	24	24
01	FINE FREQUENCY					07
02	GLIDE RATE					01
03	LFO	01	01	01		01
04	ENVLOPE AMOUNT					
05	INVERT					
06	ATTACK					
07	DECAY					
08	SUSTAIN					
09	RELEASE					
10	SAWTOOTH WAVE	01	01	01	01	01
11	TRIANGLE WAVE					
12	PULSE WAVE					
13	PULSE WIDTH		52			59
14	LFO		01			01
LFO	FREQUENCY		08			08
15	PROG AMOUNT		02			02
16	TRI/SQUARE WAVE					
17						
FILTER						
18	OSC/NOISE MIXER					
19	CUTOFF FREQUENCY	78	105			84
20	RESONANCE					05
21	ENVLOPE AMOUNT	15				01
22	INVERT					
23	ATTACK	02				07
24	DECAY	03				03
25	SUSTAIN	06				06
26	RELEASE	03				04
27	LFO					
28	KEYBOARD					
29	OSC TRI MOD AMT	01	02			02
AMP						
30	ATTACK		03			03
31	DECAY		13			06
32	SUSTAIN	15				05
33	RELEASE	01	06			06
34	VOICE VOLUME	12	10			19
35	UNISON					

FACTORY PROGRAM #:	NAME:	MOD-WHEEL:	NOTES:	PARAMETERS	VALUE
56	Vocalina			OSCILLATOR	OS
57	Puckly 1			OSCILLATOR	OS
58	5th of Otr - unison			OSCILLATOR	OS
59	Maridipom			OSCILLATOR	OS
19	Recursive Organ 2			OSCILLATOR	OS
11				OSCILLATOR	OS

FACTORY PROGRAM #:	NAME:	MOD-WHEEL:	NOTES:	PARAMETERS	VALUE
60	COARSE FREQUENCY			OSCILLATOR	24
61	FINE FREQUENCY			OSCILLATOR	24
62	GLIDE RATE			OSCILLATOR	01
63	LFO			OSCILLATOR	01
64	ENVLOPE AMOUNT			OSCILLATOR	01
65	INVERT			OSCILLATOR	01
66	ATTACK			OSCILLATOR	01
67	DECAY			OSCILLATOR	01
68	SUSTAIN			OSCILLATOR	01
69	RELEASE			OSCILLATOR	01
70	SAWTOOTH WAVE			OSCILLATOR	01
71	TRIANGLE WAVE			OSCILLATOR	01
72	SQUARE WAVE			OSCILLATOR	01
73	PULSE WAVE			OSCILLATOR	01
74	LFO			OSCILLATOR	01

FACTORY PROGRAM #:	12	13	14	15	16	17
NAME:	Strings 2	Synth with Resonance 1	Synth-clav	Cur-bass	Lead with release	Polyside
MOD-WHEEL:						
NOTES:						
PARAMETERS VALUE						
(Values are 00 unless otherwise noted)						
PARAMETERS VALUE						
(Values are 00 unless otherwise noted)						
OSCILLATOR						
00 COARSE FREQUENCY	24					
01 FINE FREQUENCY		12				
02 GLIDE RATE					36	
03 LFO						
04 ENVELOPE AMOUNT		01				
05 INVERT						
06 ATTACK						
07 DECAY						
08 SUSTAIN						
09 RELEASE						
10 SAWTOOTH WAVE	01					
11 TRIANGLE WAVE					01	
12 PULSE WAVE						
13 PULSE WIDTH			01			
14 LFO						
15 LFO						
16 FREQUENCY	08					
17 PROG AMOUNT	01					
18 TRI/SQUARE WAVE						
FILTER						
18 OSC/NOISE MIXER	30					
19 CUTOFF FREQUENCY		43				
20 RESONANCE						
21 ENVELOPE AMOUNT	12					
22 INVERT						
23 ATTACK						
24 DECAY						
25 SUSTAIN						
26 RELEASE						
27 LFO						
28 KEYBOARD						
29 OSC TRI/ MOD AMT	01					
AMPLIFIER						
30 ATTACK	03					
31 DECAY		13				
32 SUSTAIN						
33 RELEASE						
34 VOICE VOLUME	09					
35 UNISON						
OSCILLATOR						
00 COARSE FREQUENCY						
01 FINE FREQUENCY			24			
02 GLIDE RATE						
03 LFO						
04 ENVELOPE AMOUNT						
05 INVERT						
06 ATTACK						
07 DECAY						
08 SUSTAIN						
09 RELEASE						
10 SAWTOOTH WAVE						
11 TRIANGLE WAVE						
12 PULSE WAVE						
13 PULSE WIDTH						
14 LFO						
15 LFO						
16 FREQUENCY						
17 TRI/SQUARE WAVE						
FILTER						
18 OSC/NOISE MIXER						
19 CUTOFF FREQUENCY						
20 RESONANCE						
21 ENVELOPE AMOUNT						
22 INVERT						
23 ATTACK						
24 DECAY						
25 SUSTAIN						
26 RELEASE						
27 LFO						
28 KEYBOARD						
29 OSC TRI/ MOD AMT						
AMPLIFIER						
30 ATTACK						
31 DECAY						
32 SUSTAIN						
33 RELEASE						
34 VOICE VOLUME						
35 UNISON						
OSCILLATOR						
00 COARSE FREQUENCY						
01 FINE FREQUENCY						
02 GLIDE RATE						
03 LFO						
04 ENVELOPE AMOUNT						
05 INVERT						
06 ATTACK						
07 DECAY						
08 SUSTAIN						
09 RELEASE						
10 SAWTOOTH WAVE						
11 TRIANGLE WAVE						
12 PULSE WAVE						
13 PULSE WIDTH						
14 LFO						
15 LFO						
16 FREQUENCY						
17 TRI/SQUARE WAVE						
FILTER						
18 OSC/NOISE MIXER						
19 CUTOFF FREQUENCY						
20 RESONANCE						
21 ENVELOPE AMOUNT						
22 INVERT						
23 ATTACK						
24 DECAY						
25 SUSTAIN						
26 RELEASE						
27 LFO						
28 KEYBOARD						
29 OSC TRI/ MOD AMT						
AMPLIFIER						
30 ATTACK						
31 DECAY						
32 SUSTAIN						
33 RELEASE						
34 VOICE VOLUME						
35 UNISON						
OSCILLATOR						
00 COARSE FREQUENCY						
01 FINE FREQUENCY						
02 GLIDE RATE						
03 LFO						
04 ENVELOPE AMOUNT						
05 INVERT						
06 ATTACK						
07 DECAY						
08 SUSTAIN						
09 RELEASE						
10 SAWTOOTH WAVE						
11 TRIANGLE WAVE						
12 PULSE WAVE						
13 PULSE WIDTH						
14 LFO						
15 LFO						
16 FREQUENCY						
17 TRI/SQUARE WAVE						
FILTER						
18 OSC/NOISE MIXER						
19 CUTOFF FREQUENCY						
20 RESONANCE						
21 ENVELOPE AMOUNT						
22 INVERT						
23 ATTACK						
24 DECAY						
25 SUSTAIN						
26 RELEASE						
27 LFO						
28 KEYBOARD						
29 OSC TRI/ MOD AMT						
AMPLIFIER						
30 ATTACK						
31 DECAY						
32 SUSTAIN						
33 RELEASE						
34 VOICE VOLUME						
35 UNISON						

FACTORY PROGRAM #:	NAME:	MOD-WHEEL:	NOTES:	FACTORY PROGRAM #:	NAME:	MOD-WHEEL:	NOTES:	FACTORY PROGRAM #:	NAME:	MOD-WHEEL:	NOTES:	FACTORY PROGRAM #:	NAME:	MOD-WHEEL:	NOTES:	FACTORY PROGRAM #:	NAME:	MOD-WHEEL:	NOTES:				
18	Ret-bass			19	Laris 1			20	Ongh Flutes			21	Slow attack brass			22	String 3			23	Release Filter		
PARAMETERS (Values are 00 unless otherwise noted)				PARAMETERS (Values are 00 unless otherwise noted)				PARAMETERS (Values are 00 unless otherwise noted)				PARAMETERS (Values are 00 unless otherwise noted)				PARAMETERS (Values are 00 unless otherwise noted)				PARAMETERS (Values are 00 unless otherwise noted)			
00	OSCILLATOR			00	OSCILLATOR			00	OSCILLATOR			00	OSCILLATOR			00	OSCILLATOR			00	OSCILLATOR		
01	COARSE FREQUENCY	36		01	COARSE FREQUENCY	26		01	COARSE FREQUENCY	24		01	COARSE FREQUENCY	24		01	COARSE FREQUENCY	24		01	COARSE FREQUENCY	24	
02	FINE FREQUENCY			02	FINE FREQUENCY			02	FINE FREQUENCY			02	FINE FREQUENCY			02	FINE FREQUENCY			02	FINE FREQUENCY		
03	GLIDE RATE			03	GLIDE RATE	01		03	GLIDE RATE			03	GLIDE RATE			03	GLIDE RATE			03	GLIDE RATE		
04	ENVLOPE AMOUNT			04	ENVLOPE AMOUNT			04	ENVLOPE AMOUNT			04	ENVLOPE AMOUNT			04	ENVLOPE AMOUNT			04	ENVLOPE AMOUNT		
05	INVERT			05	INVERT			05	INVERT			05	INVERT			05	INVERT			05	INVERT		
06	ATTACK			06	ATTACK			06	ATTACK			06	ATTACK			06	ATTACK			06	ATTACK		
07	DECAY			07	DECAY			07	DECAY			07	DECAY			07	DECAY			07	DECAY		
08	SUSTAIN			08	SUSTAIN			08	SUSTAIN			08	SUSTAIN			08	SUSTAIN			08	SUSTAIN		
09	RELEASE			09	RELEASE			09	RELEASE			09	RELEASE			09	RELEASE			09	RELEASE		
10	SAWTOOTH WAVE	01		10	SAWTOOTH WAVE			10	SAWTOOTH WAVE	01		10	SAWTOOTH WAVE			10	SAWTOOTH WAVE			10	SAWTOOTH WAVE		
11	TRIANGLE WAVE	01		11	TRIANGLE WAVE			11	TRIANGLE WAVE			11	TRIANGLE WAVE			11	TRIANGLE WAVE			11	TRIANGLE WAVE		
12	PULSE WAVE	01		12	PULSE WAVE			12	PULSE WAVE			12	PULSE WAVE			12	PULSE WAVE			12	PULSE WAVE		
13	PULSE WIDTH	65		13	PULSE WIDTH	38		13	PULSE WIDTH	38		13	PULSE WIDTH			13	PULSE WIDTH			13	PULSE WIDTH	46	
14	LFO	01		14	LFO	01		14	LFO	01		14	LFO			14	LFO			14	LFO		
15	FREQUENCY	02		15	FREQUENCY	10		15	FREQUENCY	10		15	FREQUENCY			15	FREQUENCY			15	FREQUENCY		
16	PROG AMOUNT	23		16	PROG AMOUNT	01		16	PROG AMOUNT	01		16	PROG AMOUNT			16	PROG AMOUNT			16	PROG AMOUNT		
17	TRISQUARE WAVE			17	TRISQUARE WAVE	01		17	TRISQUARE WAVE			17	TRISQUARE WAVE			17	TRISQUARE WAVE			17	TRISQUARE WAVE		
18	OSC/NOISE MIXER			18	OSC/NOISE MIXER			18	OSC/NOISE MIXER			18	OSC/NOISE MIXER			18	OSC/NOISE MIXER			18	OSC/NOISE MIXER		
19	CUTOFF FREQUENCY	33		19	CUTOFF FREQUENCY	17		19	CUTOFF FREQUENCY	17		19	CUTOFF FREQUENCY			19	CUTOFF FREQUENCY			19	CUTOFF FREQUENCY		
20	RESONANCE	24		20	RESONANCE	09		20	RESONANCE	09		20	RESONANCE			20	RESONANCE			20	RESONANCE		
21	ENVLOPE AMOUNT	12		21	ENVLOPE AMOUNT	01		21	ENVLOPE AMOUNT	02		21	ENVLOPE AMOUNT	15		21	ENVLOPE AMOUNT	04		21	ENVLOPE AMOUNT	04	
22	INVERT			22	INVERT			22	INVERT			22	INVERT			22	INVERT			22	INVERT		
23	ATTACK			23	ATTACK			23	ATTACK			23	ATTACK			23	ATTACK			23	ATTACK		
24	DECAY	03		24	DECAY	09		24	DECAY	01		24	DECAY	11		24	DECAY	11		24	DECAY	15	
25	SUSTAIN	09		25	SUSTAIN	09		25	SUSTAIN	01		25	SUSTAIN			25	SUSTAIN			25	SUSTAIN		
26	RELEASE	09		26	RELEASE	09		26	RELEASE	09		26	RELEASE			26	RELEASE			26	RELEASE		
27	KEYBOARD			27	KEYBOARD			27	KEYBOARD			27	KEYBOARD			27	KEYBOARD			27	KEYBOARD		
28	KEYBOARD			28	KEYBOARD			28	KEYBOARD			28	KEYBOARD			28	KEYBOARD			28	KEYBOARD		
29	OSC TRI MOD AMT			29	OSC TRI MOD AMT	02		29	OSC TRI MOD AMT			29	OSC TRI MOD AMT			29	OSC TRI MOD AMT			29	OSC TRI MOD AMT		
30	AMPLIFIER			30	AMPLIFIER			30	AMPLIFIER			30	AMPLIFIER			30	AMPLIFIER			30	AMPLIFIER		
31	ATTACK			31	ATTACK			31	ATTACK			31	ATTACK			31	ATTACK			31	ATTACK		
32	DECAY			32	DECAY			32	DECAY			32	DECAY			32	DECAY			32	DECAY		
33	SUSTAIN	15		33	SUSTAIN	14		33	SUSTAIN	14		33	SUSTAIN	15		33	SUSTAIN	15		33	SUSTAIN	15	
34	RELEASE	01		34	RELEASE	01		34	RELEASE	01		34	RELEASE	04		34	RELEASE	04		34	RELEASE	07	
35	VOICE VOLUME	15		35	VOICE VOLUME	10		35	VOICE VOLUME	15		35	VOICE VOLUME	10		35	VOICE VOLUME	10		35	VOICE VOLUME	11	
36	VOICE VOLUME			36	VOICE VOLUME			36	VOICE VOLUME			36	VOICE VOLUME			36	VOICE VOLUME			36	VOICE VOLUME		
37	UNISON			37	UNISON			37	UNISON			37	UNISON			37	UNISON			37	UNISON		

FACTORY PROGRAM #:	NAME:	MOD-WHEEL:	NOTES:	FACTORY PROGRAM #:	NAME:	MOD-WHEEL:	NOTES:	FACTORY PROGRAM #:	NAME:	MOD-WHEEL:	NOTES:	FACTORY PROGRAM #:	NAME:	MOD-WHEEL:	NOTES:	FACTORY PROGRAM #:	NAME:	MOD-WHEEL:	NOTES:				
24	Piano 2			25	Synth A			26	Mixed Clav-type			27	Scattered bell sound - unison			28	Synthbars 1 - unison			29	Harp		
<p>PARAMETERS (Values are 00 unless otherwise noted)</p> <p>OSCILLATOR</p> <p>00 COARSE FREQUENCY 36 01 FINE FREQUENCY 02 GLIDE RATE 03 LFO 04 ENVELOPE AMOUNT 05 INVERT 06 ATTACK 07 DECAY 08 SUSTAIN 09 RELEASE 10 SAWTOOTH WAVE 11 TRIANGLE WAVE 12 PULSE WAVE 13 PULSE WIDTH 14 LFO</p> <p>FILTER</p> <p>18 OSC/NOISE MIXER 19 CUTOFF FREQUENCY 20 RESONANCE 21 ENVELOPE AMOUNT 22 INVERT 23 ATTACK 24 DECAY 25 SUSTAIN 26 RELEASE 27 LFO 28 KEYBOARD 29 OSC TRI MOD AMT</p> <p>AMPLIFIER</p> <p>30 ATTACK 31 SUSTAIN 32 SUSTAIN 33 RELEASE 34 VOICE VOLUME 35 UNISON</p>																							
<p>PARAMETERS (Values are 00 unless otherwise noted)</p> <p>OSCILLATOR</p> <p>00 COARSE FREQUENCY 36 01 FINE FREQUENCY 12 02 GLIDE RATE 03 LFO 01 04 ENVELOPE AMOUNT 05 INVERT 06 ATTACK 07 DECAY 08 SUSTAIN 09 RELEASE 10 SAWTOOTH WAVE 11 TRIANGLE WAVE 12 PULSE WAVE 13 PULSE WIDTH 14 LFO</p> <p>FILTER</p> <p>18 OSC/NOISE MIXER 03 19 CUTOFF FREQUENCY 55 20 RESONANCE 29 21 ENVELOPE AMOUNT 08 22 INVERT 23 ATTACK 24 DECAY 10 25 SUSTAIN 26 RELEASE 07 27 LFO 28 KEYBOARD 29 OSC TRI MOD AMT</p> <p>AMPLIFIER</p> <p>30 ATTACK 31 SUSTAIN 32 SUSTAIN 33 RELEASE 34 VOICE VOLUME 11 35 UNISON</p>																							
<p>PARAMETERS (Values are 00 unless otherwise noted)</p> <p>OSCILLATOR</p> <p>00 COARSE FREQUENCY 36 01 FINE FREQUENCY 02 GLIDE RATE 03 LFO 04 ENVELOPE AMOUNT 05 INVERT 06 ATTACK 07 DECAY 08 SUSTAIN 09 RELEASE 10 SAWTOOTH WAVE 11 TRIANGLE WAVE 12 PULSE WAVE 13 PULSE WIDTH 14 LFO</p> <p>FILTER</p> <p>18 OSC/NOISE MIXER 19 CUTOFF FREQUENCY 17 20 RESONANCE 21 ENVELOPE AMOUNT 12 22 INVERT 23 ATTACK 24 DECAY 04 25 SUSTAIN 10 26 RELEASE 10 27 LFO 28 KEYBOARD 29 OSC TRI MOD AMT</p> <p>AMPLIFIER</p> <p>30 ATTACK 31 SUSTAIN 32 SUSTAIN 33 RELEASE 34 VOICE VOLUME 13 35 UNISON</p>																							
<p>PARAMETERS (Values are 00 unless otherwise noted)</p> <p>OSCILLATOR</p> <p>00 COARSE FREQUENCY 24 01 FINE FREQUENCY 02 GLIDE RATE 03 LFO 01 04 ENVELOPE AMOUNT 05 INVERT 06 ATTACK 07 DECAY 08 SUSTAIN 09 RELEASE 10 SAWTOOTH WAVE 11 TRIANGLE WAVE 12 PULSE WAVE 13 PULSE WIDTH 14 LFO</p> <p>FILTER</p> <p>18 OSC/NOISE MIXER 03 19 CUTOFF FREQUENCY 44 20 RESONANCE 30 21 ENVELOPE AMOUNT 09 22 INVERT 23 ATTACK 24 DECAY 25 SUSTAIN 26 RELEASE 27 LFO 28 KEYBOARD 29 OSC TRI MOD AMT</p> <p>AMPLIFIER</p> <p>30 ATTACK 31 SUSTAIN 32 SUSTAIN 33 RELEASE 34 VOICE VOLUME 10 35 UNISON</p>																							
<p>PARAMETERS (Values are 00 unless otherwise noted)</p> <p>OSCILLATOR</p> <p>00 COARSE FREQUENCY 01 FINE FREQUENCY 36 02 GLIDE RATE 36 03 LFO 04 ENVELOPE AMOUNT 05 INVERT 06 ATTACK 07 DECAY 08 SUSTAIN 09 RELEASE 10 SAWTOOTH WAVE 11 TRIANGLE WAVE 12 PULSE WAVE 13 PULSE WIDTH 14 LFO</p> <p>FILTER</p> <p>18 OSC/NOISE MIXER 19 CUTOFF FREQUENCY 20 RESONANCE 21 ENVELOPE AMOUNT 22 INVERT 23 ATTACK 24 DECAY 25 SUSTAIN 26 RELEASE 27 LFO 28 KEYBOARD 29 OSC TRI MOD AMT</p> <p>AMPLIFIER</p> <p>30 ATTACK 31 SUSTAIN 32 SUSTAIN 33 RELEASE 34 VOICE VOLUME 11 35 UNISON</p>																							
<p>PARAMETERS (Values are 00 unless otherwise noted)</p> <p>OSCILLATOR</p> <p>00 COARSE FREQUENCY 01 FINE FREQUENCY 02 GLIDE RATE 03 LFO 04 ENVELOPE AMOUNT 05 INVERT 06 ATTACK 07 DECAY 08 SUSTAIN 09 RELEASE 10 SAWTOOTH WAVE 11 TRIANGLE WAVE 12 PULSE WAVE 13 PULSE WIDTH 14 LFO</p> <p>FILTER</p> <p>18 OSC/NOISE MIXER 19 CUTOFF FREQUENCY 20 RESONANCE 21 ENVELOPE AMOUNT 22 INVERT 23 ATTACK 24 DECAY 25 SUSTAIN 26 RELEASE 27 LFO 28 KEYBOARD 29 OSC TRI MOD AMT</p> <p>AMPLIFIER</p> <p>30 ATTACK 31 SUSTAIN 32 SUSTAIN 33 RELEASE 34 VOICE VOLUME 10 35 UNISON</p>																							

FACTORY PROGRAM #:	NAME:	MOD-WHEEL:	NOTES:	FACTORY PROGRAM #:	NAME:	MOD-WHEEL:	NOTES:	FACTORY PROGRAM #:	NAME:	MOD-WHEEL:	NOTES:	FACTORY PROGRAM #:	NAME:	MOD-WHEEL:	NOTES:	FACTORY PROGRAM #:	NAME:	MOD-WHEEL:	NOTES:				
30	Donald Duck organ			31	Cornet			32	Strings (brnrgd) &			33	High Jazzy			34	Electric Piano			35	Obiecloards		
PARAMETERS (Values are 00 unless otherwise noted)				PARAMETERS (Values are 00 unless otherwise noted)				PARAMETERS (Values are 00 unless otherwise noted)				PARAMETERS (Values are 00 unless otherwise noted)				PARAMETERS (Values are 00 unless otherwise noted)							
00	COARSE FREQUENCY	24		00	COARSE FREQUENCY	36		00	COARSE FREQUENCY	24		00	COARSE FREQUENCY	36		00	COARSE FREQUENCY	36		00	COARSE FREQUENCY	24	
01	FINE FREQUENCY			01	FINE FREQUENCY			01	FINE FREQUENCY			01	FINE FREQUENCY			01	FINE FREQUENCY			01	FINE FREQUENCY		
02	GLIDE RATE			02	GLIDE RATE			02	GLIDE RATE			02	GLIDE RATE			02	GLIDE RATE			02	GLIDE RATE		
03	LFO			03	LFO			03	LFO			03	LFO			03	LFO			03	LFO		
04	ENVELOPE AMOUNT			04	ENVELOPE AMOUNT			04	ENVELOPE AMOUNT			04	ENVELOPE AMOUNT			04	ENVELOPE AMOUNT			04	ENVELOPE AMOUNT		
05	INVERT			05	INVERT			05	INVERT			05	INVERT			05	INVERT			05	INVERT		
06	ATTACK			06	ATTACK			06	ATTACK			06	ATTACK			06	ATTACK			06	ATTACK		
07	DECAY			07	DECAY			07	DECAY			07	DECAY			07	DECAY			07	DECAY		
08	SUSTAIN			08	SUSTAIN			08	SUSTAIN			08	SUSTAIN			08	SUSTAIN			08	SUSTAIN		
09	RELEASE			09	RELEASE			09	RELEASE			09	RELEASE			09	RELEASE			09	RELEASE		
10	SAWTOOTH WAVE			10	SAWTOOTH WAVE			10	SAWTOOTH WAVE			10	SAWTOOTH WAVE			10	SAWTOOTH WAVE			10	SAWTOOTH WAVE		
11	TRIANGLE WAVE			11	TRIANGLE WAVE			11	TRIANGLE WAVE			11	TRIANGLE WAVE			11	TRIANGLE WAVE			11	TRIANGLE WAVE		
12	PULSE WAVE			12	PULSE WAVE			12	PULSE WAVE			12	PULSE WAVE			12	PULSE WAVE			12	PULSE WAVE		
13	PULSE WIDTH			13	PULSE WIDTH			13	PULSE WIDTH			13	PULSE WIDTH			13	PULSE WIDTH			13	PULSE WIDTH		
14	LFO			14	LFO			14	LFO			14	LFO			14	LFO			14	LFO		
LFO	FREQUENCY	12		LFO	FREQUENCY	11		LFO	FREQUENCY	08		LFO	FREQUENCY	09		LFO	FREQUENCY	15		LFO	FREQUENCY	03	
15	PROG AMOUNT	03		15	PROG AMOUNT			15	PROG AMOUNT			15	PROG AMOUNT			15	PROG AMOUNT			15	PROG AMOUNT		
16	TRI/SQUARE WAVE			16	TRI/SQUARE WAVE			16	TRI/SQUARE WAVE			16	TRI/SQUARE WAVE			16	TRI/SQUARE WAVE			16	TRI/SQUARE WAVE		
17				17				17				17				17				17			
18	OSC/NOISE MIXER			18	OSC/NOISE MIXER			18	OSC/NOISE MIXER			18	OSC/NOISE MIXER			18	OSC/NOISE MIXER			18	OSC/NOISE MIXER		
19	CUTOFF FREQUENCY	04		19	CUTOFF FREQUENCY	07		19	CUTOFF FREQUENCY	104		19	CUTOFF FREQUENCY	126		19	CUTOFF FREQUENCY	47		19	CUTOFF FREQUENCY	03	
20	RESONANCE			20	RESONANCE			20	RESONANCE			20	RESONANCE			20	RESONANCE			20	RESONANCE		
21	ENVELOPE AMOUNT			21	ENVELOPE AMOUNT			21	ENVELOPE AMOUNT			21	ENVELOPE AMOUNT			21	ENVELOPE AMOUNT			21	ENVELOPE AMOUNT		
22	INVERT			22	INVERT			22	INVERT			22	INVERT			22	INVERT			22	INVERT		
23	ATTACK			23	ATTACK			23	ATTACK			23	ATTACK			23	ATTACK			23	ATTACK		
24	DECAY			24	DECAY			24	DECAY			24	DECAY			24	DECAY			24	DECAY		
25	SUSTAIN			25	SUSTAIN			25	SUSTAIN			25	SUSTAIN			25	SUSTAIN			25	SUSTAIN		
26	RELEASE			26	RELEASE			26	RELEASE			26	RELEASE			26	RELEASE			26	RELEASE		
27	LFO			27	LFO			27	LFO			27	LFO			27	LFO			27	LFO		
28	KEYBOARD			28	KEYBOARD			28	KEYBOARD			28	KEYBOARD			28	KEYBOARD			28	KEYBOARD		
29	OSC TRI MOD AMT			29	OSC TRI MOD AMT			29	OSC TRI MOD AMT			29	OSC TRI MOD AMT			29	OSC TRI MOD AMT			29	OSC TRI MOD AMT		
30	AMPLIFIER			30	AMPLIFIER			30	AMPLIFIER			30	AMPLIFIER			30	AMPLIFIER			30	AMPLIFIER		
31	ATTACK			31	ATTACK			31	ATTACK			31	ATTACK			31	ATTACK			31	ATTACK		
32	SUSTAIN			32	SUSTAIN			32	SUSTAIN			32	SUSTAIN			32	SUSTAIN			32	SUSTAIN		
33	RELEASE			33	RELEASE			33	RELEASE			33	RELEASE			33	RELEASE			33	RELEASE		
34	VOICE VOLUME			34	VOICE VOLUME			34	VOICE VOLUME			34	VOICE VOLUME			34	VOICE VOLUME			34	VOICE VOLUME		
35	UNISON			35	UNISON			35	UNISON			35	UNISON			35	UNISON			35	UNISON		

FACTORY PROGRAM #:	36	37	38	39	42	41
NAME:	Clav-like w/ slight release	Synthbass 2 - unison	Synthbass detuned - unison	Inverted pluck	Unison organ	Brassy vibrato
MOD-WHEEL:						
NOTES:						
PARAMETERS	VALUE	VALUE	VALUE	VALUE	VALUE	VALUE
(Values are 00 unless otherwise noted)						
OSCILLATOR						
00	FINE FREQUENCY	12	07	36	36	36
01	FINE FREQUENCY	10	01	01	01	01
02	GLIDE RATE	01	01	01	01	01
03	LFO					
04	ENVELOPE AMOUNT					
05	INVERT					
06	ATTACK					
07	DECAY					
08	SUSTAIN					
09	RELEASE					
10	SAWTOOTH WAVE	01	01	01	01	01
11	TRIANGLE WAVE	01	01	01	01	01
12	PULSE WAVE	01	01	01	01	01
13	PULSE WIDTH	01	01	01	01	01
14	LFO					
LFO						
15	FREQUENCY	11	15	10	13	11
16	PRG AMOUNT		02	01		02
17	TRISQUARE WAVE					
FILTER						
18	OSC/NOISE MIXER					
19	CUTOFF FREQUENCY	102	116	113	09	42
20	RESONANCE	06	08	11	22	19
21	ENVELOPE AMOUNT	02		01	15	03
22	INVERT			02		
23	ATTACK			02		03
24	DECAY	09	02	02		09
25	SUSTAIN	07	09	02	11	09
26	RELEASE	15	09	08	09	02
27	LFO			01		
28	KEYBOARD			02		02
29	OSC TRI MOD AMT	02	01	02	02	02
AMPLIFIER						
30	ATTACK					
31	DECAY	11	01			
32	SUSTAIN	03	01	15	15	15
33	RELEASE	03	01	05	02	01
34	VOICE VOLUME	15	15	15	11	11
35	UNISON		01			

FACTORY PROGRAM #:	NAME:	MOD-WHEEL:	NOTES:	FACTORY PROGRAM #:	NAME:	MOD-WHEEL:	NOTES:	FACTORY PROGRAM #:	NAME:	MOD-WHEEL:	NOTES:	FACTORY PROGRAM #:	NAME:	MOD-WHEEL:	NOTES:	FACTORY PROGRAM #:	NAME:	MOD-WHEEL:	NOTES:				
42	String Swell			43	Seraphim			44	Jan 1			45	Pennywhistle			46	Lori's 2			47	Lucky Man		
PARAMETERS (Values are 00 unless otherwise noted)																							
00	OSCILLATOR			00	OSCILLATOR			00	OSCILLATOR			00	OSCILLATOR			00	OSCILLATOR			00	OSCILLATOR		
01	COARSE FREQUENCY	70		01	COARSE FREQUENCY	36		01	COARSE FREQUENCY	36		01	COARSE FREQUENCY	48		01	COARSE FREQUENCY	36		01	COARSE FREQUENCY	12	
02	FINE FREQUENCY			02	FINE FREQUENCY	09		02	FINE FREQUENCY	01		02	FINE FREQUENCY	01		02	FINE FREQUENCY	01		02	FINE FREQUENCY	11	
03	GLIDE RATE			03	GLIDE RATE	01		03	GLIDE RATE	01		03	GLIDE RATE	01		03	GLIDE RATE	01		03	GLIDE RATE	01	
04	ENVLOPE AMOUNT			04	ENVLOPE AMOUNT			04	ENVLOPE AMOUNT			04	ENVLOPE AMOUNT			04	ENVLOPE AMOUNT			04	ENVLOPE AMOUNT		
05	INVERT			05	INVERT			05	INVERT			05	INVERT			05	INVERT			05	INVERT		
06	ATTACK			06	ATTACK			06	ATTACK			06	ATTACK			06	ATTACK			06	ATTACK		
07	DECAY			07	DECAY			07	DECAY			07	DECAY			07	DECAY			07	DECAY		
08	SUSTAIN			08	SUSTAIN			08	SUSTAIN			08	SUSTAIN			08	SUSTAIN			08	SUSTAIN		
09	RELEASE			09	RELEASE			09	RELEASE			09	RELEASE			09	RELEASE			09	RELEASE		
10	SAWTOOTH WAVE			10	SAWTOOTH WAVE			10	SAWTOOTH WAVE	01		10	SAWTOOTH WAVE			10	SAWTOOTH WAVE			10	SAWTOOTH WAVE		
11	TRIANGLE WAVE			11	TRIANGLE WAVE	01		11	TRIANGLE WAVE			11	TRIANGLE WAVE	01		11	TRIANGLE WAVE			11	TRIANGLE WAVE		01
12	PULSE WAVE			12	PULSE WAVE			12	PULSE WAVE			12	PULSE WAVE			12	PULSE WAVE			12	PULSE WAVE		
13	PULSE WIDTH	01		13	PULSE WIDTH			13	PULSE WIDTH	01		13	PULSE WIDTH	30		13	PULSE WIDTH			13	PULSE WIDTH		
14	LFO			14	LFO			14	LFO			14	LFO			14	LFO			14	LFO		
15	FREQUENCY	07		15	FREQUENCY	09		15	FREQUENCY	12		15	FREQUENCY	01		15	FREQUENCY	10		15	FREQUENCY		11
16	ENVLOPE AMT			16	ENVLOPE AMT			16	ENVLOPE AMT			16	ENVLOPE AMT			16	ENVLOPE AMT			16	ENVLOPE AMT		
17	TRISQUARE WAVE			17	TRISQUARE WAVE			17	TRISQUARE WAVE			17	TRISQUARE WAVE			17	TRISQUARE WAVE			17	TRISQUARE WAVE		
FILTER																							
18	OSC/NOISE MIXER			18	OSC/NOISE MIXER			18	OSC/NOISE MIXER			18	OSC/NOISE MIXER			18	OSC/NOISE MIXER			18	OSC/NOISE MIXER		
19	CUTOFF FREQUENCY	88		19	CUTOFF FREQUENCY	62		19	CUTOFF FREQUENCY	63		19	CUTOFF FREQUENCY	37		19	CUTOFF FREQUENCY	127		19	CUTOFF FREQUENCY		84
20	ENVLOPE AMOUNT			20	ENVLOPE AMOUNT	05		20	ENVLOPE AMOUNT	08		20	ENVLOPE AMOUNT	09		20	ENVLOPE AMOUNT			20	ENVLOPE AMOUNT		11
21	INVERT			21	INVERT			21	INVERT			21	INVERT			21	INVERT			21	INVERT		
22	ATTACK			22	ATTACK			22	ATTACK			22	ATTACK			22	ATTACK			22	ATTACK		
23	DECAY			23	DECAY			23	DECAY			23	DECAY			23	DECAY			23	DECAY		
24	SUSTAIN			24	SUSTAIN			24	SUSTAIN			24	SUSTAIN			24	SUSTAIN			24	SUSTAIN		12
25	RELEASE			25	RELEASE			25	RELEASE			25	RELEASE			25	RELEASE			25	RELEASE		12
26	KEYBOARD			26	KEYBOARD			26	KEYBOARD			26	KEYBOARD			26	KEYBOARD			26	KEYBOARD		
27	OSC TRI MOD AMT			27	OSC TRI MOD AMT			27	OSC TRI MOD AMT			27	OSC TRI MOD AMT			27	OSC TRI MOD AMT			27	OSC TRI MOD AMT		
28	AMPLIFIER			28	AMPLIFIER			28	AMPLIFIER			28	AMPLIFIER			28	AMPLIFIER			28	AMPLIFIER		
29	ATTACK			29	ATTACK			29	ATTACK			29	ATTACK			29	ATTACK			29	ATTACK		
30	DECAY			30	DECAY			30	DECAY			30	DECAY			30	DECAY			30	DECAY		
31	SUSTAIN			31	SUSTAIN			31	SUSTAIN			31	SUSTAIN			31	SUSTAIN			31	SUSTAIN		
32	RELEASE			32	RELEASE			32	RELEASE			32	RELEASE			32	RELEASE			32	RELEASE		
33	VOICE VOLUME	07		33	VOICE VOLUME	05		33	VOICE VOLUME	15		33	VOICE VOLUME	11		33	VOICE VOLUME	10		33	VOICE VOLUME		15
34	UNISON			34	UNISON			34	UNISON			34	UNISON			34	UNISON			34	UNISON		
35	UNISON			35	UNISON			35	UNISON			35	UNISON			35	UNISON			35	UNISON		

FACTORY PROGRAM #:	NAME:	MOD-WHEEL:	NOTES:	FACTORY PROGRAM #:	NAME:	MOD-WHEEL:	NOTES:	FACTORY PROGRAM #:	NAME:	MOD-WHEEL:	NOTES:	FACTORY PROGRAM #:	NAME:	MOD-WHEEL:	NOTES:	FACTORY PROGRAM #:	NAME:	MOD-WHEEL:	NOTES:				
48	Cut-bass 2 - unison			49	Clav 3			50	Percussive Organ 3			51	Grok brass			52	Miribano Strings			53	George Frederick		
PARAMETERS VALUE				PARAMETERS VALUE				PARAMETERS VALUE				PARAMETERS VALUE				PARAMETERS VALUE				PARAMETERS VALUE			
(Values are 50 unless otherwise noted)				(Values are 50 unless otherwise noted)				(Values are 50 unless otherwise noted)				(Values are 50 unless otherwise noted)				(Values are 50 unless otherwise noted)				(Values are 50 unless otherwise noted)			
01	OSCILLATOR			01	OSCILLATOR			01	OSCILLATOR			01	OSCILLATOR			01	OSCILLATOR			01	OSCILLATOR		
02	FINE FREQUENCY	12		02	FINE FREQUENCY	25		02	FINE FREQUENCY	36		02	FINE FREQUENCY	24		02	FINE FREQUENCY			02	FINE FREQUENCY		
03	GLIDE RATE	01		03	GLIDE RATE	01		03	GLIDE RATE	01		03	GLIDE RATE	01		03	GLIDE RATE			03	GLIDE RATE		
04	ENVLOPE AMOUNT			04	ENVLOPE AMOUNT			04	ENVLOPE AMOUNT			04	ENVLOPE AMOUNT			04	ENVLOPE AMOUNT			04	ENVLOPE AMOUNT		
05	INVERT			05	INVERT			05	INVERT			05	INVERT			05	INVERT			05	INVERT		
06	ATTACK			06	ATTACK			06	ATTACK			06	ATTACK			06	ATTACK			06	ATTACK		
07	DECAY			07	DECAY			07	DECAY			07	DECAY			07	DECAY			07	DECAY		
08	SUSTAIN			08	SUSTAIN			08	SUSTAIN			08	SUSTAIN			08	SUSTAIN			08	SUSTAIN		
09	RELEASE			09	RELEASE			09	RELEASE			09	RELEASE			09	RELEASE			09	RELEASE		
10	SAWTOOTH WAVE	01		10	SAWTOOTH WAVE	01		10	SAWTOOTH WAVE	01		10	SAWTOOTH WAVE	01		10	SAWTOOTH WAVE			10	SAWTOOTH WAVE		
11	TRIANGLE WAVE	01		11	TRIANGLE WAVE	01		11	TRIANGLE WAVE	01		11	TRIANGLE WAVE	01		11	TRIANGLE WAVE			11	TRIANGLE WAVE		
12	PULSE WAVE	01		12	PULSE WAVE	01		12	PULSE WAVE	01		12	PULSE WAVE	01		12	PULSE WAVE			12	PULSE WAVE		
13	PULSE WIDTH	31		13	PULSE WIDTH	22		13	PULSE WIDTH	01		13	PULSE WIDTH	55		13	PULSE WIDTH			13	PULSE WIDTH		
14	LFO			14	LFO			14	LFO	01		14	LFO	01		14	LFO			14	LFO		
15	FREQUENCY	11		15	FREQUENCY			15	FREQUENCY	11		15	FREQUENCY	08		15	FREQUENCY			15	FREQUENCY		
16	PROG AMOUNT			16	PROG AMOUNT			16	PROG AMOUNT	31		16	PROG AMOUNT	02		16	PROG AMOUNT			16	PROG AMOUNT		
17	TRI/SQUARE WAVE			17	TRI/SQUARE WAVE			17	TRI/SQUARE WAVE			17	TRI/SQUARE WAVE			17	TRI/SQUARE WAVE			17	TRI/SQUARE WAVE		
FILTER				FILTER				FILTER				FILTER				FILTER				FILTER			
18	OSC/NOISE MIXER	03		18	OSC/NOISE MIXER	71		18	OSC/NOISE MIXER	84		18	OSC/NOISE MIXER	71		18	OSC/NOISE MIXER			18	OSC/NOISE MIXER		
19	CUTOFF FREQUENCY	34		19	CUTOFF FREQUENCY	56		19	CUTOFF FREQUENCY	29		19	CUTOFF FREQUENCY	05		19	CUTOFF FREQUENCY	113		19	CUTOFF FREQUENCY		
20	RESONANCE	15		20	RESONANCE	08		20	RESONANCE	04		20	RESONANCE	05		20	RESONANCE			20	RESONANCE		
21	ENVLOPE AMOUNT			21	ENVLOPE AMOUNT			21	ENVLOPE AMOUNT			21	ENVLOPE AMOUNT			21	ENVLOPE AMOUNT			21	ENVLOPE AMOUNT		
22	INVERT			22	INVERT			22	INVERT			22	INVERT			22	INVERT			22	INVERT		
23	ATTACK			23	ATTACK			23	ATTACK			23	ATTACK	02		23	ATTACK			23	ATTACK		
24	DECAY	12		24	DECAY	03		24	DECAY	03		24	DECAY	13		24	DECAY			24	DECAY		
25	SUSTAIN	13		25	SUSTAIN	15		25	SUSTAIN	03		25	SUSTAIN	04		25	SUSTAIN			25	SUSTAIN		
26	RELEASE	15		26	RELEASE			26	RELEASE			26	RELEASE	01		26	RELEASE			26	RELEASE		
27	KEYBOARD	01		27	KEYBOARD	01		27	KEYBOARD	02		27	KEYBOARD	02		27	KEYBOARD			27	KEYBOARD		
28	LFO			28	LFO			28	LFO			28	LFO			28	LFO			28	LFO		
29	OSC TRI MOD AMT	18		29	OSC TRI MOD AMT	01		29	OSC TRI MOD AMT	02		29	OSC TRI MOD AMT	02		29	OSC TRI MOD AMT			29	OSC TRI MOD AMT		
AMPLIFIER				AMPLIFIER				AMPLIFIER				AMPLIFIER				AMPLIFIER				AMPLIFIER			
30	ATTACK	03		30	ATTACK	07		30	ATTACK			30	ATTACK	66		30	ATTACK			30	ATTACK		
31	DECAY	31		31	DECAY	33		31	DECAY	16		31	DECAY	05		31	DECAY			31	DECAY		
32	SUSTAIN	03		32	SUSTAIN	02		32	SUSTAIN	01		32	SUSTAIN	06		32	SUSTAIN			32	SUSTAIN		
33	RELEASE	03		33	RELEASE	11		33	RELEASE	12		33	RELEASE	15		33	RELEASE			33	RELEASE		
34	VOICE VOLUME	09		34	VOICE VOLUME	11		34	VOICE VOLUME	12		34	VOICE VOLUME	15		34	VOICE VOLUME			34	VOICE VOLUME		
35	UNISON	01		35	UNISON			35	UNISON			35	UNISON			35	UNISON			35	UNISON		

FACTORY PROGRAM #:	NAME: MOD:WHEEL: NOTES:	VALUE	PARAMETERS (Values are 00 unless otherwise noted)	FACTORY PROGRAM #:	NAME: MOD:WHEEL: NOTES:	VALUE	PARAMETERS (Values are 00 unless otherwise noted)	FACTORY PROGRAM #:	NAME: MOD:WHEEL: NOTES:	VALUE	PARAMETERS (Values are 00 unless otherwise noted)	FACTORY PROGRAM #:	NAME: MOD:WHEEL: NOTES:	VALUE	PARAMETERS (Values are 00 unless otherwise noted)								
34	Jan 2 - unison		OSCILLATOR 00 COARSE FREQUENCY 24 01 FINE FREQUENCY 02 GLIDE RATE 03 LFO 04 ENVELOPE AMOUNT 05 INVERT 06 ATTACK 07 SUSTAIN 08 SUSTAIN 09 RELEASE 10 SAWTOOTH WAVE 11 TRIANGLE WAVE 12 PULSE WAVE 13 PULSE WIDTH 14 LFO	35	Full synth		OSCILLATOR 00 COARSE FREQUENCY 12 01 FINE FREQUENCY 02 GLIDE RATE 03 LFO 04 ENVELOPE AMOUNT 05 INVERT 06 ATTACK 07 SUSTAIN 08 SUSTAIN 09 RELEASE 10 SAWTOOTH WAVE 11 TRIANGLE WAVE 12 PULSE WAVE 13 PULSE WIDTH 14 LFO	36	Twang		OSCILLATOR 00 COARSE FREQUENCY 12 01 FINE FREQUENCY 02 GLIDE RATE 03 LFO 04 ENVELOPE AMOUNT 05 INVERT 06 ATTACK 07 SUSTAIN 08 SUSTAIN 09 RELEASE 10 SAWTOOTH WAVE 11 TRIANGLE WAVE 12 PULSE WAVE 13 PULSE WIDTH 14 LFO	37	Clavet		OSCILLATOR 00 COARSE FREQUENCY 12 01 FINE FREQUENCY 02 GLIDE RATE 03 LFO 04 ENVELOPE AMOUNT 05 INVERT 06 ATTACK 07 SUSTAIN 08 SUSTAIN 09 RELEASE 10 SAWTOOTH WAVE 11 TRIANGLE WAVE 12 PULSE WAVE 13 PULSE WIDTH 14 LFO	38	Bezmod		OSCILLATOR 00 COARSE FREQUENCY 24 01 FINE FREQUENCY 02 GLIDE RATE 03 LFO 04 ENVELOPE AMOUNT 05 INVERT 06 ATTACK 07 SUSTAIN 08 SUSTAIN 09 RELEASE 10 SAWTOOTH WAVE 11 TRIANGLE WAVE 12 PULSE WAVE 13 PULSE WIDTH 14 LFO	39	Plucky 2		OSCILLATOR 00 COARSE FREQUENCY 36 01 FINE FREQUENCY 02 GLIDE RATE 03 LFO 04 ENVELOPE AMOUNT 05 INVERT 06 ATTACK 07 SUSTAIN 08 SUSTAIN 09 RELEASE 10 SAWTOOTH WAVE 11 TRIANGLE WAVE 12 PULSE WAVE 13 PULSE WIDTH 14 LFO
15			LFO	15			FREQUENCY	15			FREQUENCY	15			FREQUENCY								
16			PROG-AMOUNT	16			PROG-AMOUNT	16			PROG-AMOUNT	16			PROG-AMOUNT								
17			TRISQUARE WAVE	17			TRISQUARE WAVE	17			TRISQUARE WAVE	17			TRISQUARE WAVE								
18			FILTER	18			FILTER	18			FILTER	18			FILTER								
19			OSC/NOISE MIXER	19			OSC/NOISE MIXER	19			OSC/NOISE MIXER	19			OSC/NOISE MIXER								
20			CUTOFF FREQUENCY	20			CUTOFF FREQUENCY	20			CUTOFF FREQUENCY	20			CUTOFF FREQUENCY								
21			RESONANCE	21			RESONANCE	21			RESONANCE	21			RESONANCE								
22			ENVELOPE AMOUNT	22			ENVELOPE AMOUNT	22			ENVELOPE AMOUNT	22			ENVELOPE AMOUNT								
23			ATTACK	23			ATTACK	23			ATTACK	23			ATTACK								
24			DECAY	24			DECAY	24			DECAY	24			DECAY								
25			SUSTAIN	25			SUSTAIN	25			SUSTAIN	25			SUSTAIN								
26			RELEASE	26			RELEASE	26			RELEASE	26			RELEASE								
27			LFO	27			LFO	27			LFO	27			LFO								
28			KEYBOARD	28			KEYBOARD	28			KEYBOARD	28			KEYBOARD								
29			OSC TRI MOD AMT	29			OSC TRI MOD AMT	29			OSC TRI MOD AMT	29			OSC TRI MOD AMT								
30			AMPLIFIER	30			AMPLIFIER	30			AMPLIFIER	30			AMPLIFIER								
31			ATTACK	31			ATTACK	31			ATTACK	31			ATTACK								
32			DECAY	32			DECAY	32			DECAY	32			DECAY								
33			SUSTAIN	33			SUSTAIN	33			SUSTAIN	33			SUSTAIN								
34			VOICE VOLUME	34			VOICE VOLUME	34			VOICE VOLUME	34			VOICE VOLUME								
35			UNISON	35			UNISON	35			UNISON	35			UNISON								

FACTORY PROGRAM #:	NAME:	MOD-WHEEL:	NOTES:	FACTORY PROGRAM #:	NAME:	MOD-WHEEL:	NOTES:	FACTORY PROGRAM #:	NAME:	MOD-WHEEL:	NOTES:	FACTORY PROGRAM #:	NAME:	MOD-WHEEL:	NOTES:	FACTORY PROGRAM #:	NAME:	MOD-WHEEL:	NOTES:				
60	Flies			61	Synth with Resonance 3			62	String with Filter sweep			63	Echo			64	Synth B			65	Hose Pose		
PARAMETERS (Values are 00 unless otherwise noted)				PARAMETERS (Values are 00 unless otherwise noted)				PARAMETERS (Values are 00 unless otherwise noted)				PARAMETERS (Values are 00 unless otherwise noted)				PARAMETERS (Values are 00 unless otherwise noted)				PARAMETERS (Values are 00 unless otherwise noted)			
07	OSCILLATOR			07	OSCILLATOR			07	OSCILLATOR			07	OSCILLATOR			07	OSCILLATOR			07	OSCILLATOR		
08	FINE FREQUENCY	24		08	FINE FREQUENCY	22		08	FINE FREQUENCY	24		08	FINE FREQUENCY	48		08	FINE FREQUENCY	24		08	FINE FREQUENCY	12	
09	GLIDE RATE			09	GLIDE RATE			09	GLIDE RATE			09	GLIDE RATE			09	GLIDE RATE			09	GLIDE RATE		
10	LFO			10	LFO			10	LFO			10	LFO			10	LFO			10	LFO		
11	ENVLOPE AMOUNT	15		11	ENVLOPE AMOUNT	04		11	ENVLOPE AMOUNT			11	ENVLOPE AMOUNT			11	ENVLOPE AMOUNT			11	ENVLOPE AMOUNT	15	
12	INVERT			12	INVERT			12	INVERT			12	INVERT			12	INVERT			12	INVERT		
13	DECAY			13	DECAY	01		13	DECAY			13	DECAY			13	DECAY			13	DECAY		
14	SUSTAIN			14	SUSTAIN	15		14	SUSTAIN			14	SUSTAIN			14	SUSTAIN			14	SUSTAIN		
15	RELEASE	13		15	RELEASE	03		15	RELEASE			15	RELEASE			15	RELEASE			15	RELEASE		
16	SAWTOOTH WAVE			16	SAWTOOTH WAVE			16	SAWTOOTH WAVE			16	SAWTOOTH WAVE	01		16	SAWTOOTH WAVE			16	SAWTOOTH WAVE		
17	TRIANGLE WAVE	01		17	TRIANGLE WAVE	01		17	TRIANGLE WAVE	01		17	TRIANGLE WAVE	01		17	TRIANGLE WAVE			17	TRIANGLE WAVE		
18	PULSE WAVE	01		18	PULSE WAVE	01		18	PULSE WAVE	01		18	PULSE WAVE	01		18	PULSE WAVE			18	PULSE WAVE		
19	PULSE WIDTH	01		19	PULSE WIDTH	01		19	PULSE WIDTH	40		19	PULSE WIDTH			19	PULSE WIDTH			19	PULSE WIDTH		
20	LFO			20	LFO			20	LFO			20	LFO			20	LFO			20	LFO		
21	FREQUENCY	08		21	FREQUENCY	07		21	FREQUENCY	12		21	FREQUENCY			21	FREQUENCY			21	FREQUENCY	09	
22	PROG AMOUNT	06		22	PROG AMOUNT	11		22	PROG AMOUNT	13		22	PROG AMOUNT			22	PROG AMOUNT			22	PROG AMOUNT	01	
23	TRI/SQUARE WAVE			23	TRI/SQUARE WAVE			23	TRI/SQUARE WAVE			23	TRI/SQUARE WAVE			23	TRI/SQUARE WAVE			23	TRI/SQUARE WAVE		
24	OSC/NOISE MIXER			24	OSC/NOISE MIXER			24	OSC/NOISE MIXER			24	OSC/NOISE MIXER			24	OSC/NOISE MIXER			24	OSC/NOISE MIXER		
25	CUTOFF FREQUENCY	31		25	CUTOFF FREQUENCY	37		25	OSC/NOISE MIXER			25	CUTOFF FREQUENCY	43		25	OSC/NOISE MIXER			25	CUTOFF FREQUENCY	09	
26	RESONANCE	13		26	RESONANCE	10		26	RESONANCE	49		26	RESONANCE	04		26	RESONANCE			26	RESONANCE	01	
27	ENVLOPE AMOUNT			27	ENVLOPE AMOUNT	10		27	ENVLOPE AMOUNT	13		27	ENVLOPE AMOUNT	02		27	ENVLOPE AMOUNT			27	ENVLOPE AMOUNT	13	
28	INVERT			28	INVERT	01		28	INVERT			28	INVERT	02		28	INVERT			28	INVERT		
29	ATTACK			29	ATTACK	01		29	ATTACK	06		29	ATTACK	02		29	ATTACK			29	ATTACK		
30	DECAY	10		30	DECAY	06		30	DECAY	06		30	DECAY	02		30	DECAY			30	DECAY		
31	SUSTAIN	13		31	SUSTAIN	06		31	SUSTAIN	06		31	SUSTAIN	02		31	SUSTAIN			31	SUSTAIN		
32	RELEASE	03		32	RELEASE	06		32	RELEASE	11		32	RELEASE	02		32	RELEASE			32	RELEASE		
33	KEYBOARD	03		33	KEYBOARD	02		33	KEYBOARD			33	KEYBOARD	02		33	KEYBOARD			33	KEYBOARD		
34	OSC TRI MOD AMT	39		34	OSC TRI MOD AMT			34	OSC TRI MOD AMT	02		34	OSC TRI MOD AMT			34	OSC TRI MOD AMT			34	OSC TRI MOD AMT		
35	AMPLIFIER			35	AMPLIFIER			35	AMPLIFIER			35	AMPLIFIER			35	AMPLIFIER			35	AMPLIFIER		
36	ATTACK	11		36	ATTACK	13		36	ATTACK			36	ATTACK			36	ATTACK			36	ATTACK		
37	DECAY			37	DECAY			37	DECAY			37	DECAY			37	DECAY			37	DECAY		
38	SUSTAIN	05		38	SUSTAIN	01		38	SUSTAIN	15		38	SUSTAIN	05		38	SUSTAIN			38	SUSTAIN	15	
39	RELEASE	08		39	RELEASE	11		39	RELEASE	10		39	RELEASE	11		39	RELEASE			39	RELEASE	10	
40	VOICE VOLUME			40	VOICE VOLUME	11		40	VOICE VOLUME	10		40	VOICE VOLUME	11		40	VOICE VOLUME			40	VOICE VOLUME	10	
41	UNISON			41	UNISON			41	UNISON			41	UNISON			41	UNISON			41	UNISON		

FACTORY PROGRAM #: 66			FACTORY PROGRAM #: 67			FACTORY PROGRAM #: 68			FACTORY PROGRAM #: 69			FACTORY PROGRAM #: 70			FACTORY PROGRAM #: 71					
NAME:	MOD-WHEEL:	NOTES:	NAME:	MOD-WHEEL:	NOTES:	NAME:	MOD-WHEEL:	NOTES:	NAME:	MOD-WHEEL:	NOTES:	NAME:	MOD-WHEEL:	NOTES:	NAME:	MOD-WHEEL:	NOTES:			
PARAMETERS:	VALUE	(Values are 00 unless otherwise noted)	PARAMETERS:	VALUE	(Values are 00 unless otherwise noted)	PARAMETERS:	VALUE	(Values are 00 unless otherwise noted)	PARAMETERS:	VALUE	(Values are 00 unless otherwise noted)	PARAMETERS:	VALUE	(Values are 00 unless otherwise noted)	PARAMETERS:	VALUE	(Values are 00 unless otherwise noted)			
OSCILLATOR	00	COARSE FREQUENCY	36	OSCILLATOR	00	COARSE FREQUENCY	48	OSCILLATOR	00	COARSE FREQUENCY	36	OSCILLATOR	00	COARSE FREQUENCY	36	OSCILLATOR	00	COARSE FREQUENCY		
01	FINE FREQUENCY		01	FINE FREQUENCY		01	FINE FREQUENCY		01	FINE FREQUENCY		01	FINE FREQUENCY		01	FINE FREQUENCY		01	FINE FREQUENCY	
02	GLIDE RATE		02	GLIDE RATE		02	GLIDE RATE		02	GLIDE RATE		02	GLIDE RATE		02	GLIDE RATE		02	GLIDE RATE	
03	LFO	ENVELOPE AMOUNT	06	LFO	ENVELOPE AMOUNT	06	LFO	ENVELOPE AMOUNT	06	LFO	ENVELOPE AMOUNT	06	LFO	ENVELOPE AMOUNT	06	LFO	ENVELOPE AMOUNT	06	LFO	ENVELOPE AMOUNT
04	INVERT	ATTACK	07	INVERT	ATTACK	07	INVERT	ATTACK	07	INVERT	ATTACK	07	INVERT	ATTACK	07	INVERT	ATTACK	07	INVERT	ATTACK
05	DECAY	SUSTAIN	08	DECAY	SUSTAIN	08	DECAY	SUSTAIN	08	DECAY	SUSTAIN	08	DECAY	SUSTAIN	08	DECAY	SUSTAIN	08	DECAY	SUSTAIN
06	RELEASE	SAWTOOTH WAVE	09	RELEASE	SAWTOOTH WAVE	09	RELEASE	SAWTOOTH WAVE	09	RELEASE	SAWTOOTH WAVE	09	RELEASE	SAWTOOTH WAVE	09	RELEASE	SAWTOOTH WAVE	09	RELEASE	SAWTOOTH WAVE
07	SUSTAIN	TRIANGLE WAVE	10	SUSTAIN	TRIANGLE WAVE	10	SUSTAIN	TRIANGLE WAVE	10	SUSTAIN	TRIANGLE WAVE	10	SUSTAIN	TRIANGLE WAVE	10	SUSTAIN	TRIANGLE WAVE	10	SUSTAIN	TRIANGLE WAVE
08	RELEASE	PULSE WAVE	11	RELEASE	PULSE WAVE	11	RELEASE	PULSE WAVE	11	RELEASE	PULSE WAVE	11	RELEASE	PULSE WAVE	11	RELEASE	PULSE WAVE	11	RELEASE	PULSE WAVE
09	SAWTOOTH WAVE	PULSE WIDTH	21	SAWTOOTH WAVE	PULSE WIDTH	21	SAWTOOTH WAVE	PULSE WIDTH	21	SAWTOOTH WAVE	PULSE WIDTH	21	SAWTOOTH WAVE	PULSE WIDTH	21	SAWTOOTH WAVE	PULSE WIDTH	21	SAWTOOTH WAVE	PULSE WIDTH
10	TRIANGLE WAVE	LFO	01	TRIANGLE WAVE	LFO	01	TRIANGLE WAVE	LFO	01	TRIANGLE WAVE	LFO	01	TRIANGLE WAVE	LFO	01	TRIANGLE WAVE	LFO	01	TRIANGLE WAVE	LFO
11	PULSE WAVE	FREQUENCY	12	PULSE WAVE	FREQUENCY	12	PULSE WAVE	FREQUENCY	12	PULSE WAVE	FREQUENCY	12	PULSE WAVE	FREQUENCY	12	PULSE WAVE	FREQUENCY	12	PULSE WAVE	FREQUENCY
12	PULSE WIDTH	PROG AMOUNT	31	PULSE WIDTH	PROG AMOUNT	31	PULSE WIDTH	PROG AMOUNT	31	PULSE WIDTH	PROG AMOUNT	31	PULSE WIDTH	PROG AMOUNT	31	PULSE WIDTH	PROG AMOUNT	31	PULSE WIDTH	PROG AMOUNT
13	LFO	TRI/SQUARE WAVE	08	LFO	TRI/SQUARE WAVE	08	LFO	TRI/SQUARE WAVE	08	LFO	TRI/SQUARE WAVE	08	LFO	TRI/SQUARE WAVE	08	LFO	TRI/SQUARE WAVE	08	LFO	TRI/SQUARE WAVE
14	FREQUENCY	OSC/NOISE MIXER	18	FREQUENCY	OSC/NOISE MIXER	18	FREQUENCY	OSC/NOISE MIXER	18	FREQUENCY	OSC/NOISE MIXER	18	FREQUENCY	OSC/NOISE MIXER	18	FREQUENCY	OSC/NOISE MIXER	18	FREQUENCY	OSC/NOISE MIXER
15	PROG AMOUNT	CUTOFF FREQUENCY	63	PROG AMOUNT	CUTOFF FREQUENCY	63	PROG AMOUNT	CUTOFF FREQUENCY	63	PROG AMOUNT	CUTOFF FREQUENCY	63	PROG AMOUNT	CUTOFF FREQUENCY	63	PROG AMOUNT	CUTOFF FREQUENCY	63	PROG AMOUNT	CUTOFF FREQUENCY
16	TRI/SQUARE WAVE	RESONANCE	07	TRI/SQUARE WAVE	RESONANCE	07	TRI/SQUARE WAVE	RESONANCE	07	TRI/SQUARE WAVE	RESONANCE	07	TRI/SQUARE WAVE	RESONANCE	07	TRI/SQUARE WAVE	RESONANCE	07	TRI/SQUARE WAVE	RESONANCE
FILTER	18	ENVELOPE AMOUNT	07	FILTER	18	ENVELOPE AMOUNT	07	FILTER	18	ENVELOPE AMOUNT	07	FILTER	18	ENVELOPE AMOUNT	07	FILTER	18	ENVELOPE AMOUNT	07	FILTER
19	OSC/NOISE MIXER	ATTACK	23	OSC/NOISE MIXER	ATTACK	23	OSC/NOISE MIXER	ATTACK	23	OSC/NOISE MIXER	ATTACK	23	OSC/NOISE MIXER	ATTACK	23	OSC/NOISE MIXER	ATTACK	23	OSC/NOISE MIXER	ATTACK
20	CUTOFF FREQUENCY	DECAY	24	CUTOFF FREQUENCY	DECAY	24	CUTOFF FREQUENCY	DECAY	24	CUTOFF FREQUENCY	DECAY	24	CUTOFF FREQUENCY	DECAY	24	CUTOFF FREQUENCY	DECAY	24	CUTOFF FREQUENCY	DECAY
21	RESONANCE	SUSTAIN	25	RESONANCE	SUSTAIN	25	RESONANCE	SUSTAIN	25	RESONANCE	SUSTAIN	25	RESONANCE	SUSTAIN	25	RESONANCE	SUSTAIN	25	RESONANCE	SUSTAIN
22	ENVELOPE AMOUNT	RELEASE	26	ENVELOPE AMOUNT	RELEASE	26	ENVELOPE AMOUNT	RELEASE	26	ENVELOPE AMOUNT	RELEASE	26	ENVELOPE AMOUNT	RELEASE	26	ENVELOPE AMOUNT	RELEASE	26	ENVELOPE AMOUNT	RELEASE
23	OSC/NOISE MIXER	LFO	27	OSC/NOISE MIXER	LFO	27	OSC/NOISE MIXER	LFO	27	OSC/NOISE MIXER	LFO	27	OSC/NOISE MIXER	LFO	27	OSC/NOISE MIXER	LFO	27	OSC/NOISE MIXER	LFO
24	CUTOFF FREQUENCY	KEYBOARD	28	CUTOFF FREQUENCY	KEYBOARD	28	CUTOFF FREQUENCY	KEYBOARD	28	CUTOFF FREQUENCY	KEYBOARD	28	CUTOFF FREQUENCY	KEYBOARD	28	CUTOFF FREQUENCY	KEYBOARD	28	CUTOFF FREQUENCY	KEYBOARD
25	RESONANCE	OSC TRI MOD AMT	29	RESONANCE	OSC TRI MOD AMT	29	RESONANCE	OSC TRI MOD AMT	29	RESONANCE	OSC TRI MOD AMT	29	RESONANCE	OSC TRI MOD AMT	29	RESONANCE	OSC TRI MOD AMT	29	RESONANCE	OSC TRI MOD AMT
26	ENVELOPE AMOUNT	AMPLIFIER	30	ENVELOPE AMOUNT	AMPLIFIER	30	ENVELOPE AMOUNT	AMPLIFIER	30	ENVELOPE AMOUNT	AMPLIFIER	30	ENVELOPE AMOUNT	AMPLIFIER	30	ENVELOPE AMOUNT	AMPLIFIER	30	ENVELOPE AMOUNT	AMPLIFIER
27	OSC/NOISE MIXER	DECAY	31	OSC/NOISE MIXER	DECAY	31	OSC/NOISE MIXER	DECAY	31	OSC/NOISE MIXER	DECAY	31	OSC/NOISE MIXER	DECAY	31	OSC/NOISE MIXER	DECAY	31	OSC/NOISE MIXER	DECAY
28	CUTOFF FREQUENCY	SUSTAIN	32	CUTOFF FREQUENCY	SUSTAIN	32	CUTOFF FREQUENCY	SUSTAIN	32	CUTOFF FREQUENCY	SUSTAIN	32	CUTOFF FREQUENCY	SUSTAIN	32	CUTOFF FREQUENCY	SUSTAIN	32	CUTOFF FREQUENCY	SUSTAIN
29	RESONANCE	RELEASE	33	RESONANCE	RELEASE	33	RESONANCE	RELEASE	33	RESONANCE	RELEASE	33	RESONANCE	RELEASE	33	RESONANCE	RELEASE	33	RESONANCE	RELEASE
30	ENVELOPE AMOUNT	VOICE VOLUME	34	ENVELOPE AMOUNT	VOICE VOLUME	34	ENVELOPE AMOUNT	VOICE VOLUME	34	ENVELOPE AMOUNT	VOICE VOLUME	34	ENVELOPE AMOUNT	VOICE VOLUME	34	ENVELOPE AMOUNT	VOICE VOLUME	34	ENVELOPE AMOUNT	VOICE VOLUME
31	OSC/NOISE MIXER	UNISON	35	OSC/NOISE MIXER	UNISON	35	OSC/NOISE MIXER	UNISON	35	OSC/NOISE MIXER	UNISON	35	OSC/NOISE MIXER	UNISON	35	OSC/NOISE MIXER	UNISON	35	OSC/NOISE MIXER	UNISON

FACTORY PROGRAM #:	NAME:	MOD-WHEEL:	NOTES:	FACTORY PROGRAM #:	NAME:	MOD-WHEEL:	NOTES:	FACTORY PROGRAM #:	NAME:	MOD-WHEEL:	NOTES:	FACTORY PROGRAM #:	NAME:	MOD-WHEEL:	NOTES:	FACTORY PROGRAM #:	NAME:	MOD-WHEEL:	NOTES:				
72	Argelic			73	Fluicy Page			74	Pulse-width mod 2			75	Harpichord			76	Smith with resonance 4			77	Acoustic Piano - part 1		
PARAMETERS (Values are 00 unless otherwise noted)				PARAMETERS (Values are 00 unless otherwise noted)				PARAMETERS (Values are 00 unless otherwise noted)				PARAMETERS (Values are 00 unless otherwise noted)				PARAMETERS (Values are 00 unless otherwise noted)				PARAMETERS (Values are 00 unless otherwise noted)			
00	OSCILLATOR			00	OSCILLATOR			00	OSCILLATOR			00	OSCILLATOR			00	OSCILLATOR			00	OSCILLATOR		
01	COARSE FREQUENCY	48		01	COARSE FREQUENCY	43		01	COARSE FREQUENCY	29		01	COARSE FREQUENCY	28		01	COARSE FREQUENCY	36		01	COARSE FREQUENCY	36	
02	FINE FREQUENCY	12		02	FINE FREQUENCY	03		02	FINE FREQUENCY	03		02	FINE FREQUENCY	03		02	FINE FREQUENCY	03		02	FINE FREQUENCY	03	
03	LFO			03	LFO			03	LFO			03	LFO			03	LFO			03	LFO		
04	ENVELOPE AMOUNT	01		04	ENVELOPE AMOUNT	01		04	ENVELOPE AMOUNT	01		04	ENVELOPE AMOUNT	01		04	ENVELOPE AMOUNT	01		04	ENVELOPE AMOUNT	01	
05	INVERT			05	INVERT			05	INVERT			05	INVERT			05	INVERT			05	INVERT		
06	ATTACK			06	ATTACK			06	ATTACK			06	ATTACK			06	ATTACK			06	ATTACK		
07	DECAY			07	DECAY			07	DECAY			07	DECAY			07	DECAY			07	DECAY		
08	SUSTAIN			08	SUSTAIN			08	SUSTAIN			08	SUSTAIN			08	SUSTAIN			08	SUSTAIN		
09	RELEASE			09	RELEASE			09	RELEASE			09	RELEASE			09	RELEASE			09	RELEASE		
10	SAWTOOTH WAVE			10	SAWTOOTH WAVE			10	SAWTOOTH WAVE			10	SAWTOOTH WAVE			10	SAWTOOTH WAVE			10	SAWTOOTH WAVE		
11	TRIANGLE WAVE			11	TRIANGLE WAVE			11	TRIANGLE WAVE			11	TRIANGLE WAVE			11	TRIANGLE WAVE			11	TRIANGLE WAVE		
12	PULSE WAVE			12	PULSE WAVE			12	PULSE WAVE			12	PULSE WAVE			12	PULSE WAVE			12	PULSE WAVE		
13	PULSE WIDTH	56		13	PULSE WIDTH	13		13	PULSE WIDTH	56		13	PULSE WIDTH	01		13	PULSE WIDTH			13	PULSE WIDTH		
14	LFO			14	LFO			14	LFO			14	LFO			14	LFO			14	LFO		
15	FREQUENCY	11		15	FREQUENCY	08		15	FREQUENCY	06		15	FREQUENCY	06		15	FREQUENCY	11		15	FREQUENCY	11	
16	PROG AMOUNT	03		16	PROG AMOUNT	17		16	PROG AMOUNT	31		16	PROG AMOUNT	17		16	PROG AMOUNT	17		16	PROG AMOUNT	17	
17	TRISQUARE WAVE			17	TRISQUARE WAVE			17	TRISQUARE WAVE			17	TRISQUARE WAVE			17	TRISQUARE WAVE			17	TRISQUARE WAVE		
18	FILTER			18	FILTER			18	FILTER			18	FILTER			18	FILTER			18	FILTER		
19	OSC/NOISE MIXER			19	OSC/NOISE MIXER			19	OSC/NOISE MIXER			19	OSC/NOISE MIXER			19	OSC/NOISE MIXER			19	OSC/NOISE MIXER		
20	CUTOFF FREQUENCY	76		20	CUTOFF FREQUENCY	76		20	CUTOFF FREQUENCY	33		20	CUTOFF FREQUENCY	103		20	CUTOFF FREQUENCY	63		20	CUTOFF FREQUENCY	63	
21	RESONANCE	32		21	RESONANCE	03		21	RESONANCE	55		21	RESONANCE	26		21	RESONANCE	22		21	RESONANCE	22	
22	ENVELOPE AMOUNT	01		22	ENVELOPE AMOUNT	03		22	ENVELOPE AMOUNT	03		22	ENVELOPE AMOUNT	01		22	ENVELOPE AMOUNT	10		22	ENVELOPE AMOUNT	10	
23	INVERT			23	INVERT			23	INVERT			23	INVERT			23	INVERT			23	INVERT		
24	ATTACK			24	ATTACK			24	ATTACK			24	ATTACK			24	ATTACK			24	ATTACK		
25	DECAY			25	DECAY			25	DECAY			25	DECAY			25	DECAY			25	DECAY		
26	SUSTAIN			26	SUSTAIN			26	SUSTAIN			26	SUSTAIN			26	SUSTAIN			26	SUSTAIN		
27	RELEASE			27	RELEASE			27	RELEASE			27	RELEASE			27	RELEASE			27	RELEASE		
28	LFO			28	LFO			28	LFO			28	LFO			28	LFO			28	LFO		
29	KEYBOARD			29	KEYBOARD			29	KEYBOARD			29	KEYBOARD			29	KEYBOARD			29	KEYBOARD		
30	OSC TRI MOD AMT			30	OSC TRI MOD AMT			30	OSC TRI MOD AMT			30	OSC TRI MOD AMT			30	OSC TRI MOD AMT			30	OSC TRI MOD AMT		
31	AMPLIFIER			31	AMPLIFIER			31	AMPLIFIER			31	AMPLIFIER			31	AMPLIFIER			31	AMPLIFIER		
32	ATTACK	56		32	ATTACK	09		32	ATTACK			32	ATTACK			32	ATTACK			32	ATTACK		
33	DECAY	06		33	DECAY	09		33	DECAY			33	DECAY			33	DECAY			33	DECAY		
34	SUSTAIN	06		34	SUSTAIN	09		34	SUSTAIN	15		34	SUSTAIN	19		34	SUSTAIN			34	SUSTAIN		
35	RELEASE	06		35	RELEASE	09		35	RELEASE	06		35	RELEASE	06		35	RELEASE			35	RELEASE		
36	VOICE VOLUME	10		36	VOICE VOLUME	11		36	VOICE VOLUME	11		36	VOICE VOLUME	15		36	VOICE VOLUME			36	VOICE VOLUME		
37	UNISON			37	UNISON			37	UNISON			37	UNISON			37	UNISON			37	UNISON		

FACTORY PROGRAM #:	NAME:	MOD-WHEEL:	NOTES:	FACTORY PROGRAM #:	NAME:	MOD-WHEEL:	NOTES:	FACTORY PROGRAM #:	NAME:	MOD-WHEEL:	NOTES:	FACTORY PROGRAM #:	NAME:	MOD-WHEEL:	NOTES:	FACTORY PROGRAM #:	NAME:	MOD-WHEEL:	NOTES:
75	Celestial			79	Colliswood Jr.			83	Inverted Clamorous			31	Moov			32	Wind		
PARAMETERS	VALUE	PARAMETERS	VALUE	PARAMETERS	VALUE	PARAMETERS	VALUE	PARAMETERS	VALUE	PARAMETERS	VALUE	PARAMETERS	VALUE	PARAMETERS	VALUE	PARAMETERS	VALUE	PARAMETERS	VALUE
(Values are 00 unless otherwise noted)																			
OSCILLATOR		OSCILLATOR		OSCILLATOR		OSCILLATOR		OSCILLATOR		OSCILLATOR		OSCILLATOR		OSCILLATOR		OSCILLATOR		OSCILLATOR	
00	COARSE FREQUENCY	00	COARSE FREQUENCY	00	COARSE FREQUENCY	00	COARSE FREQUENCY	00	COARSE FREQUENCY	00	COARSE FREQUENCY	00	COARSE FREQUENCY	00	COARSE FREQUENCY	00	COARSE FREQUENCY	00	COARSE FREQUENCY
01	FINE FREQUENCY	01	FINE FREQUENCY	01	FINE FREQUENCY	01	FINE FREQUENCY	01	FINE FREQUENCY	01	FINE FREQUENCY	01	FINE FREQUENCY	01	FINE FREQUENCY	01	FINE FREQUENCY	01	FINE FREQUENCY
02	GLIDE RATE	02	GLIDE RATE	02	GLIDE RATE	02	GLIDE RATE	02	GLIDE RATE	02	GLIDE RATE	02	GLIDE RATE	02	GLIDE RATE	02	GLIDE RATE	02	GLIDE RATE
03	LFO	03	LFO	03	LFO	03	LFO	03	LFO	03	LFO	03	LFO	03	LFO	03	LFO	03	LFO
04	ENVLOPE AMOUNT	04	ENVLOPE AMOUNT	04	ENVLOPE AMOUNT	04	ENVLOPE AMOUNT	04	ENVLOPE AMOUNT	04	ENVLOPE AMOUNT	04	ENVLOPE AMOUNT	04	ENVLOPE AMOUNT	04	ENVLOPE AMOUNT	04	ENVLOPE AMOUNT
05	INVERT	05	INVERT	05	INVERT	05	INVERT	05	INVERT	05	INVERT	05	INVERT	05	INVERT	05	INVERT	05	INVERT
06	ATTACK	06	ATTACK	06	ATTACK	06	ATTACK	06	ATTACK	06	ATTACK	06	ATTACK	06	ATTACK	06	ATTACK	06	ATTACK
07	DECAY	07	DECAY	07	DECAY	07	DECAY	07	DECAY	07	DECAY	07	DECAY	07	DECAY	07	DECAY	07	DECAY
08	SUSTAIN	08	SUSTAIN	08	SUSTAIN	08	SUSTAIN	08	SUSTAIN	08	SUSTAIN	08	SUSTAIN	08	SUSTAIN	08	SUSTAIN	08	SUSTAIN
09	RELEASE	09	RELEASE	09	RELEASE	09	RELEASE	09	RELEASE	09	RELEASE	09	RELEASE	09	RELEASE	09	RELEASE	09	RELEASE
10	SAWTOOTH WAVE	10	SAWTOOTH WAVE	10	SAWTOOTH WAVE	10	SAWTOOTH WAVE	10	SAWTOOTH WAVE	10	SAWTOOTH WAVE	10	SAWTOOTH WAVE	10	SAWTOOTH WAVE	10	SAWTOOTH WAVE	10	SAWTOOTH WAVE
11	TRIANGLE WAVE	11	TRIANGLE WAVE	11	TRIANGLE WAVE	11	TRIANGLE WAVE	11	TRIANGLE WAVE	11	TRIANGLE WAVE	11	TRIANGLE WAVE	11	TRIANGLE WAVE	11	TRIANGLE WAVE	11	TRIANGLE WAVE
12	PULSE WAVE	12	PULSE WAVE	12	PULSE WAVE	12	PULSE WAVE	12	PULSE WAVE	12	PULSE WAVE	12	PULSE WAVE	12	PULSE WAVE	12	PULSE WAVE	12	PULSE WAVE
13	PULSE WIDTH	13	PULSE WIDTH	13	PULSE WIDTH	13	PULSE WIDTH	13	PULSE WIDTH	13	PULSE WIDTH	13	PULSE WIDTH	13	PULSE WIDTH	13	PULSE WIDTH	13	PULSE WIDTH
14	LFO	14	LFO	14	LFO	14	LFO	14	LFO	14	LFO	14	LFO	14	LFO	14	LFO	14	LFO
15	FREQUENCY	15	FREQUENCY	15	FREQUENCY	15	FREQUENCY	15	FREQUENCY	15	FREQUENCY	15	FREQUENCY	15	FREQUENCY	15	FREQUENCY	15	FREQUENCY
16	PRCG AMOUNT	16	PRCG AMOUNT	16	PRCG AMOUNT	16	PRCG AMOUNT	16	PRCG AMOUNT	16	PRCG AMOUNT	16	PRCG AMOUNT	16	PRCG AMOUNT	16	PRCG AMOUNT	16	PRCG AMOUNT
17	TRISQUARE WAVE	17	TRISQUARE WAVE	17	TRISQUARE WAVE	17	TRISQUARE WAVE	17	TRISQUARE WAVE	17	TRISQUARE WAVE	17	TRISQUARE WAVE	17	TRISQUARE WAVE	17	TRISQUARE WAVE	17	TRISQUARE WAVE
FILTER		FILTER		FILTER		FILTER		FILTER		FILTER		FILTER		FILTER		FILTER		FILTER	
18	OSC/NOISE MIXER	18	OSC/NOISE MIXER	18	OSC/NOISE MIXER	18	OSC/NOISE MIXER	18	OSC/NOISE MIXER	18	OSC/NOISE MIXER	18	OSC/NOISE MIXER	18	OSC/NOISE MIXER	18	OSC/NOISE MIXER	18	OSC/NOISE MIXER
19	CUTOFF FREQUENCY	19	CUTOFF FREQUENCY	19	CUTOFF FREQUENCY	19	CUTOFF FREQUENCY	19	CUTOFF FREQUENCY	19	CUTOFF FREQUENCY	19	CUTOFF FREQUENCY	19	CUTOFF FREQUENCY	19	CUTOFF FREQUENCY	19	CUTOFF FREQUENCY
20	RESONANCE	20	RESONANCE	20	RESONANCE	20	RESONANCE	20	RESONANCE	20	RESONANCE	20	RESONANCE	20	RESONANCE	20	RESONANCE	20	RESONANCE
21	ENVLOPE AMOUNT	21	ENVLOPE AMOUNT	21	ENVLOPE AMOUNT	21	ENVLOPE AMOUNT	21	ENVLOPE AMOUNT	21	ENVLOPE AMOUNT	21	ENVLOPE AMOUNT	21	ENVLOPE AMOUNT	21	ENVLOPE AMOUNT	21	ENVLOPE AMOUNT
22	INVERT	22	INVERT	22	INVERT	22	INVERT	22	INVERT	22	INVERT	22	INVERT	22	INVERT	22	INVERT	22	INVERT
23	ATTACK	23	ATTACK	23	ATTACK	23	ATTACK	23	ATTACK	23	ATTACK	23	ATTACK	23	ATTACK	23	ATTACK	23	ATTACK
24	DECAY	24	DECAY	24	DECAY	24	DECAY	24	DECAY	24	DECAY	24	DECAY	24	DECAY	24	DECAY	24	DECAY
25	SUSTAIN	25	SUSTAIN	25	SUSTAIN	25	SUSTAIN	25	SUSTAIN	25	SUSTAIN	25	SUSTAIN	25	SUSTAIN	25	SUSTAIN	25	SUSTAIN
26	RELEASE	26	RELEASE	26	RELEASE	26	RELEASE	26	RELEASE	26	RELEASE	26	RELEASE	26	RELEASE	26	RELEASE	26	RELEASE
27	LFO	27	LFO	27	LFO	27	LFO	27	LFO	27	LFO	27	LFO	27	LFO	27	LFO	27	LFO
28	KEYBOARD	28	KEYBOARD	28	KEYBOARD	28	KEYBOARD	28	KEYBOARD	28	KEYBOARD	28	KEYBOARD	28	KEYBOARD	28	KEYBOARD	28	KEYBOARD
29	OSC TRI MOD AMT	29	OSC TRI MOD AMT	29	OSC TRI MOD AMT	29	OSC TRI MOD AMT	29	OSC TRI MOD AMT	29	OSC TRI MOD AMT	29	OSC TRI MOD AMT	29	OSC TRI MOD AMT	29	OSC TRI MOD AMT	29	OSC TRI MOD AMT
AMPPLIER		AMPPLIER		AMPPLIER		AMPPLIER		AMPPLIER		AMPPLIER		AMPPLIER		AMPPLIER		AMPPLIER		AMPPLIER	
30	ATTACK	30	ATTACK	30	ATTACK	30	ATTACK	30	ATTACK	30	ATTACK	30	ATTACK	30	ATTACK	30	ATTACK	30	ATTACK
31	DECAY	31	DECAY	31	DECAY	31	DECAY	31	DECAY	31	DECAY	31	DECAY	31	DECAY	31	DECAY	31	DECAY
32	SUSTAIN	32	SUSTAIN	32	SUSTAIN	32	SUSTAIN	32	SUSTAIN	32	SUSTAIN	32	SUSTAIN	32	SUSTAIN	32	SUSTAIN	32	SUSTAIN
33	RELEASE	33	RELEASE	33	RELEASE	33	RELEASE	33	RELEASE	33	RELEASE	33	RELEASE	33	RELEASE	33	RELEASE	33	RELEASE
34	VOICE VOLUME	34	VOICE VOLUME	34	VOICE VOLUME	34	VOICE VOLUME	34	VOICE VOLUME	34	VOICE VOLUME	34	VOICE VOLUME	34	VOICE VOLUME	34	VOICE VOLUME	34	VOICE VOLUME
35	UNISON	35	UNISON	35	UNISON	35	UNISON	35	UNISON	35	UNISON	35	UNISON	35	UNISON	35	UNISON	35	UNISON

FACTORY PROGRAM #:	NAME:	MOD-WHEEL:	NOTES:	FACTORY PROGRAM #:	NAME:	MOD-WHEEL:	NOTES:	FACTORY PROGRAM #:	NAME:	MOD-WHEEL:	NOTES:	FACTORY PROGRAM #:	NAME:	MOD-WHEEL:	NOTES:
84	Musical Org			85	Acoustic Piano - part 2			86	Square wave spacey			87	SFX 1		
88	Chirp-like														
PARAMETERS VALUE															
(Values are 00 unless otherwise noted)															
OSCILLATOR															
00	COARSE FREQUENCY	24		00	COARSE FREQUENCY	24		00	COARSE FREQUENCY	24		00	COARSE FREQUENCY	24	
01	FINE FREQUENCY			01	FINE FREQUENCY			01	FINE FREQUENCY			01	FINE FREQUENCY		
02	GLIDE RATE			02	GLIDE RATE			02	GLIDE RATE			02	GLIDE RATE		
03	ENVELOPE AMOUNT	01		03	ENVELOPE AMOUNT	01		03	ENVELOPE AMOUNT	01		03	ENVELOPE AMOUNT	01	
04	INVERT			04	INVERT			04	INVERT			04	INVERT		
05	ATTACK			05	ATTACK			05	ATTACK			05	ATTACK		
06	DECAY			06	DECAY			06	DECAY			06	DECAY		
07	SUSTAIN	01		07	SUSTAIN	01		07	SUSTAIN	01		07	SUSTAIN	01	
08	RELEASE			08	RELEASE			08	RELEASE			08	RELEASE		
09	SAWTOOTH WAVE			09	SAWTOOTH WAVE			09	SAWTOOTH WAVE			09	SAWTOOTH WAVE		
10	TRIANGLE WAVE			10	TRIANGLE WAVE			10	TRIANGLE WAVE			10	TRIANGLE WAVE		
11	PULSE WAVE	01		11	PULSE WAVE	01		11	PULSE WAVE	01		11	PULSE WAVE	01	
12	PULSE RATE			12	PULSE RATE			12	PULSE RATE			12	PULSE RATE		
13	PULSE WIDTH	38		13	PULSE WIDTH	38		13	PULSE WIDTH	38		13	PULSE WIDTH	38	
14	LFO	01		14	LFO	01		14	LFO	01		14	LFO	01	
15	FREQUENCY	01		15	FREQUENCY	01		15	FREQUENCY	01		15	FREQUENCY	01	
16	PROG AMOUNT	24		16	PROG AMOUNT	24		16	PROG AMOUNT	24		16	PROG AMOUNT	24	
17	TRI/SQUARE WAVE			17	TRI/SQUARE WAVE			17	TRI/SQUARE WAVE			17	TRI/SQUARE WAVE		
FILTER															
18	OSC/NOISE MIXER			18	OSC/NOISE MIXER			18	OSC/NOISE MIXER			18	OSC/NOISE MIXER		
19	CUTOFF FREQUENCY	101		19	CUTOFF FREQUENCY	127		19	CUTOFF FREQUENCY	77		19	CUTOFF FREQUENCY	77	
20	RESONANCE	40		20	RESONANCE	43		20	RESONANCE	48		20	RESONANCE	48	
21	ENVELOPE AMOUNT	15		21	ENVELOPE AMOUNT	11		21	ENVELOPE AMOUNT	11		21	ENVELOPE AMOUNT	05	
22	INVERT			22	INVERT			22	INVERT			22	INVERT		
23	ATTACK			23	ATTACK			23	ATTACK			23	ATTACK		
24	DECAY			24	DECAY			24	DECAY			24	DECAY		
25	SUSTAIN			25	SUSTAIN			25	SUSTAIN			25	SUSTAIN		
26	RELEASE			26	RELEASE			26	RELEASE			26	RELEASE		
27	LFO	01		27	LFO	01		27	LFO	01		27	LFO	01	
28	KEYBOARD	02		28	KEYBOARD	02		28	KEYBOARD	02		28	KEYBOARD	02	
29	OSC TRI MOD AMT	63		29	OSC TRI MOD AMT	34		29	OSC TRI MOD AMT	63		29	OSC TRI MOD AMT	02	
AMPLIFIER															
30	ATTACK			30	ATTACK			30	ATTACK			30	ATTACK		
31	DECAY	03		31	DECAY	03		31	DECAY	03		31	DECAY	11	
32	SUSTAIN	15		32	SUSTAIN	15		32	SUSTAIN	15		32	SUSTAIN	15	
33	RELEASE	04		33	RELEASE	14		33	RELEASE	10		33	RELEASE	03	
34	VOICE VOLUME	07		34	VOICE VOLUME	08		34	VOICE VOLUME	08		34	VOICE VOLUME	06	
35	UNISON			35	UNISON	01		35	UNISON			35	UNISON		

FACTORY PROGRAM #:	92	91	92	93	94	95
NAME:	Puce	Thudmen	Percussive noise	Ascending release	h/vs drop with release	Josef'n Coughs
MOD-WHEEL:						
NOTES:						
PARAMETERS:	VALUE	VALUE	VALUE	VALUE	VALUE	VALUE
(Values are 00 unless otherwise noted)	(Values are 00 unless otherwise noted)	(Values are 00 unless otherwise noted)	(Values are 00 unless otherwise noted)	(Values are 00 unless otherwise noted)	(Values are 00 unless otherwise noted)	(Values are 00 unless otherwise noted)
OSCILLATOR						
00	COARSE FREQUENCY 48	COARSE FREQUENCY 48	COARSE FREQUENCY 36	COARSE FREQUENCY 28	COARSE FREQUENCY 19	COARSE FREQUENCY 26
01	FINE FREQUENCY	FINE FREQUENCY 64	FINE FREQUENCY 64	FINE FREQUENCY 64	FINE FREQUENCY 64	FINE FREQUENCY 64
02	GLIDE RATE	GLIDE RATE	GLIDE RATE	GLIDE RATE	GLIDE RATE	GLIDE RATE
03	LFO	LFO	LFO	LFO	LFO	LFO
04	ENVLOPE AMOUNT 13	ENVLOPE AMOUNT 01	ENVLOPE AMOUNT 01	ENVLOPE AMOUNT 01	ENVLOPE AMOUNT 12	ENVLOPE AMOUNT 01
05	INVERT	INVERT	INVERT	INVERT	INVERT	INVERT
06	ATTACK	ATTACK	ATTACK	ATTACK	ATTACK	ATTACK
07	DECAY	DECAY	DECAY	DECAY	DECAY	DECAY
08	SUSTAIN	SUSTAIN	SUSTAIN	SUSTAIN	SUSTAIN	SUSTAIN
09	RELEASE	RELEASE	RELEASE	RELEASE	RELEASE	RELEASE
10	SAWTOOTH WAVE	SAWTOOTH WAVE 01	SAWTOOTH WAVE	SAWTOOTH WAVE	SAWTOOTH WAVE	SAWTOOTH WAVE
11	TRIANGLE WAVE	TRIANGLE WAVE	TRIANGLE WAVE	TRIANGLE WAVE	TRIANGLE WAVE	TRIANGLE WAVE
12	PULSE WAVE	PULSE WAVE	PULSE WAVE	PULSE WAVE	PULSE WAVE	PULSE WAVE
13	PULSE WIDTH 26	PULSE WIDTH 26	PULSE WIDTH	PULSE WIDTH	PULSE WIDTH	PULSE WIDTH
14	LFO	LFO	LFO	LFO	LFO	LFO
LFO	FREQUENCY	FREQUENCY	FREQUENCY	FREQUENCY	FREQUENCY	FREQUENCY
15	PROG AMOUNT	PROG AMOUNT	PROG AMOUNT	PROG AMOUNT	PROG AMOUNT	PROG AMOUNT
16	TRI/SQUARE WAVE	TRI/SQUARE WAVE	TRI/SQUARE WAVE	TRI/SQUARE WAVE	TRI/SQUARE WAVE	TRI/SQUARE WAVE
17	FILTER	FILTER	FILTER	FILTER	FILTER	FILTER
18	OSC/NOISE MIXER 18	OSC/NOISE MIXER 18	OSC/NOISE MIXER 31	OSC/NOISE MIXER 127	OSC/NOISE MIXER 30	OSC/NOISE MIXER 68
19	CUTOFF FREQUENCY 66	CUTOFF FREQUENCY 38	CUTOFF FREQUENCY 69	CUTOFF FREQUENCY 127	CUTOFF FREQUENCY 50	CUTOFF FREQUENCY 29
20	RESONANCE 01	RESONANCE 01	RESONANCE 04	RESONANCE 09	RESONANCE 09	RESONANCE 29
21	ENVLOPE AMOUNT 01	ENVLOPE AMOUNT 01	ENVLOPE AMOUNT 05	ENVLOPE AMOUNT 08	ENVLOPE AMOUNT 08	ENVLOPE AMOUNT 04
22	INVERT	INVERT	INVERT	INVERT	INVERT	INVERT
23	ATTACK	ATTACK	ATTACK	ATTACK	ATTACK	ATTACK
24	DECAY	DECAY	DECAY	DECAY	DECAY	DECAY
25	SUSTAIN	SUSTAIN	SUSTAIN	SUSTAIN	SUSTAIN	SUSTAIN
26	RELEASE	RELEASE	RELEASE	RELEASE	RELEASE	RELEASE
27	LFO	LFO	LFO	LFO	LFO	LFO
28	KEYBOARD	KEYBOARD	KEYBOARD	KEYBOARD	KEYBOARD	KEYBOARD
29	OSC TRI MOD AMT 63	OSC TRI MOD AMT 63	OSC TRI MOD AMT 63	OSC TRI MOD AMT 02	OSC TRI MOD AMT 02	OSC TRI MOD AMT 63
AMP LIFIER						
30	ATTACK	ATTACK	ATTACK	ATTACK	ATTACK	ATTACK
31	DECAY	DECAY	DECAY	DECAY	DECAY	DECAY
32	SUSTAIN	SUSTAIN	SUSTAIN	SUSTAIN	SUSTAIN	SUSTAIN
33	RELEASE	RELEASE	RELEASE	RELEASE	RELEASE	RELEASE
34	VOICE VOLUME 15	VOICE VOLUME 12	VOICE VOLUME 15	VOICE VOLUME 15	VOICE VOLUME 15	VOICE VOLUME 15
35	UNISON	UNISON	UNISON	UNISON	UNISON	UNISON

FACTORY PROGRAM #:	NAME:	MOD-WHEEL:	FACTORY PROGRAM #:	NAME:	MOD-WHEEL:	FACTORY PROGRAM #:	NAME:	MOD-WHEEL:	FACTORY PROGRAM #:	NAME:	MOD-WHEEL:
96	Inclusive wind - unison		97	Percussion 3 - unison		98	Alien - unison		99	Alien wind - unison	
PARAMETERS (Values are 00 unless otherwise noted)											
00	COARSE FREQUENCY	48	00	COARSE FREQUENCY	48	00	COARSE FREQUENCY	41	00	COARSE FREQUENCY	15
01	FINE FREQUENCY		01	FINE FREQUENCY		01	FINE FREQUENCY		01	FINE FREQUENCY	
02	GLIDE RATE		02	GLIDE RATE		02	GLIDE RATE		02	GLIDE RATE	
03	ENVLOPE AMOUNT	02	03	ENVLOPE AMOUNT	15	03	ENVLOPE AMOUNT		03	ENVLOPE AMOUNT	11
04	INVERT	01	04	INVERT	01	04	INVERT		04	INVERT	01
05	ATTACK	01	05	ATTACK	01	05	ATTACK		05	ATTACK	12
06	DECAY	02	06	DECAY	02	06	DECAY		06	DECAY	12
07	SUSTAIN	11	07	SUSTAIN	11	07	SUSTAIN		07	SUSTAIN	12
08	RELEASE	07	08	RELEASE	07	08	RELEASE		08	RELEASE	12
09	KEYBOARD	01	09	KEYBOARD	01	09	KEYBOARD		09	KEYBOARD	12
10	TRIANGLE WAVE		10	TRIANGLE WAVE		10	TRIANGLE WAVE		10	TRIANGLE WAVE	
11	PULSE WAVE	01	11	PULSE WAVE	01	11	PULSE WAVE		11	PULSE WAVE	
12	PULSE WIDTH	26	12	PULSE WIDTH	26	12	PULSE WIDTH		12	PULSE WIDTH	
13	LFO		13	LFO		13	LFO		13	LFO	
14	FREQUENCY		14	FREQUENCY		14	FREQUENCY		14	FREQUENCY	
15	PROG AMOUNT		15	PROG AMOUNT		15	PROG AMOUNT		15	PROG AMOUNT	
16	TRI/SQUARE WAVE		16	TRI/SQUARE WAVE		16	TRI/SQUARE WAVE		16	TRI/SQUARE WAVE	
17	CUTOFF FREQUENCY	18	17	CUTOFF FREQUENCY	18	17	CUTOFF FREQUENCY	81	17	CUTOFF FREQUENCY	69
18	RESONANCE	38	18	RESONANCE	38	18	RESONANCE	53	18	RESONANCE	63
19	ENVLOPE AMOUNT	03	19	ENVLOPE AMOUNT	03	19	ENVLOPE AMOUNT		19	ENVLOPE AMOUNT	
20	INVERT		20	INVERT		20	INVERT		20	INVERT	
21	ATTACK		21	ATTACK		21	ATTACK		21	ATTACK	
22	DECAY		22	DECAY		22	DECAY		22	DECAY	
23	SUSTAIN		23	SUSTAIN		23	SUSTAIN		23	SUSTAIN	
24	RELEASE		24	RELEASE		24	RELEASE		24	RELEASE	
25	KEYBOARD	02	25	KEYBOARD	02	25	KEYBOARD	01	25	KEYBOARD	01
26	OSC TRI MOD AMT	63	26	OSC TRI MOD AMT	63	26	OSC TRI MOD AMT	63	26	OSC TRI MOD AMT	27
27	AMPLIFIER		27	AMPLIFIER		27	AMPLIFIER		27	AMPLIFIER	
28	ATTACK	05	28	ATTACK	05	28	ATTACK	15	28	ATTACK	15
29	DECAY	15	29	DECAY	15	29	DECAY	12	29	DECAY	15
30	SUSTAIN	12	30	SUSTAIN	12	30	SUSTAIN	15	30	SUSTAIN	15
31	RELEASE	12	31	RELEASE	12	31	RELEASE	15	31	RELEASE	15
32	VOICE VOLUME	01	32	VOICE VOLUME	01	32	VOICE VOLUME	09	32	VOICE VOLUME	09
33	UNISON		33	UNISON		33	UNISON		33	UNISON	
34			34			34			34		
35			35			35			35		

15 YOUR PROGRAMS

NUMBER NAME/DESCRIPTION

00

01

02

03

04

05

06

07

08

09

10

11

12

13

14

15

16

17

18

19

20

21

22

23

24

25
26
27
28
29
30
31
32
33
34
35
36
37
38
39
40
41
42
43
44
45
46
47
48
49

50
51
52
53
54
55
56
57
58
59
60
61
62
63
64
65
66
67
68
69
70
71
72
73
74

75
76
77
78
79
80
81
82
83
84
85
86
87
88
89
90
91
92
93
94
95
96
97
98
99

SCI SIX-TRAK

PROGRAM NUMBER:

DESCRIPTION:

MOD-WHEEL:

NOTES:

<u>PARAMETERS</u>	<u>VALUE</u>
<u>OSCILLATOR</u>	
00	COARSE FREQUENCY
01	FINE FREQUENCY
02	GLIDE RATE
03	LFO
04	ENVELOPE AMOUNT
05	INVERT
06	ATTACK
07	DECAY
08	SUSTAIN
09	RELEASE
10	SAWTOOTH WAVE
11	TRIANGLE WAVE
12	PULSE WAVE
13	PULSE WIDTH
14	LFO
<u>LFO</u>	
15	FREQUENCY
16	PROGRAMMED AMT
17	TRI/SQUARE WAVE
<u>FILTER</u>	
18	OSC/NOISE MIXER
19	CUTOFF FREQUENCY
20	RESONANCE
21	ENVELOPE AMOUNT
22	INVERT
23	ATTACK
24	DECAY
25	SUSTAIN
26	RELEASE
27	LFO
28	KEYBOARD
29	OSC TRI MOD AMT
<u>AMPLIFIER</u>	
30	ATTACK
31	DECAY
32	SUSTAIN
33	RELEASE
34	VOICE VOLUME
35	UNISON

SEQUENTIAL CIRCUITS, INC. LIMITED WARRANTY

Please read this warranty as it gives you specific legal rights. You may also have other rights which can vary from state to state.

LENGTH OF WARRANTY

This warranty will remain in effect for one year from the date of purchase.

WHAT IS COVERED

This warranty covers all defects in material and workmanship in this product, under the condition as discussed in the following sections.

WHAT IS NOT COVERED

- 1) Damage due to accident, misuse, neglect or abuse—including damage resulting from failure to follow instructions contained in the operation manual.
- 2) Damage or deterioration of cabinet or keyboard.
- 3) Damage occurring during any shipment of the product for any reason. All claims must be handled directly with the carrier.
- 4) Damage resulting from repair or attempted repair by anyone other than Sequential Circuits, Inc. (S.C.I.) or an authorized S.C.I. Service Center.
- 5) Any unit on which the serial number has been defaced, modified or removed is not covered under this warranty.
- 6) Any modification or alteration of any kind performed by anyone including S.C.I. or an Authorized S.C.I. Service Center, will void the warranty on your unit. The only exception to this is an Authorized S.C.I. modification which includes its own warranty coverage. Due to the complexity of the circuitry, modifications tend to extend repair time and therefore increase repair costs.

HOW TO VALIDATE THE WARRANTY

Please fill in the following information for our Marketing Department. Thank you for your cooperation.

NAME _____ (PLEASE PRINT)

ADDRESS _____

CITY _____ STATE _____

ZIP _____ PHONE () _____

MODEL _____ SERIAL NO _____

DATE PURCHASED _____

PURCHASED FROM _____

AGE:

- Under 21
 22-26
 27-35
 Over 35

TYPE OF MUSIC PLAYED:

- | | | | |
|-------------|--------------------------|------------|--------------------------|
| Country | <input type="checkbox"/> | Electronic | <input type="checkbox"/> |
| Jazz | <input type="checkbox"/> | Classical | <input type="checkbox"/> |
| Rock | <input type="checkbox"/> | R & B | <input type="checkbox"/> |
| New Wave | <input type="checkbox"/> | Disco | <input type="checkbox"/> |
| Other _____ | | | |

TYPE OF MUSICIAN:

- | | | | |
|----------|--------------------------|-------------------|--------------------------|
| Student | <input type="checkbox"/> | Professional | <input type="checkbox"/> |
| Amateur | <input type="checkbox"/> | Recording Session | <input type="checkbox"/> |
| Semi-Pro | <input type="checkbox"/> | Other | _____ |

INSTRUMENTS PLAYED:

- | | | | |
|-------------|--------------------------|-------------|--------------------------|
| Brass | <input type="checkbox"/> | Woodwind | <input type="checkbox"/> |
| Percussion | <input type="checkbox"/> | Keyboard | <input type="checkbox"/> |
| Guitar | <input type="checkbox"/> | Synthesizer | <input type="checkbox"/> |
| Other _____ | | | |

Do you own a computer? _____

MUSICAL PUBLICATIONS REGULARLY READ AND REVIEWED:

- | | |
|--------------------------|--------------------------|
| Rolling Stone | <input type="checkbox"/> |
| Guitar Player | <input type="checkbox"/> |
| down beat | <input type="checkbox"/> |
| International Musician | <input type="checkbox"/> |
| Contemporary Keyboard | <input type="checkbox"/> |
| Musician Player Listener | <input type="checkbox"/> |
| Other _____ | |

WHAT INFLUENCED YOUR DECISION TO PURCHASE AN S.C.I. PRODUCT? _____

SCI SIX-TRAK

PROGRAM NUMBER:

DESCRIPTION:

MOD-WHEEL:

NOTES:

<u>PARAMETERS</u>	<u>VALUE</u>
<u>OSCILLATOR</u>	
00	COARSE FREQUENCY
01	FINE FREQUENCY
02	GLIDE RATE
03	LFO
04	ENVELOPE AMOUNT
05	INVERT
06	ATTACK
07	DECAY
08	SUSTAIN
09	RELEASE
10	SAWTOOTH WAVE
11	TRIANGLE WAVE
12	PULSE WAVE
13	PULSE WIDTH
14	LFO
<u>LFO</u>	
15	FREQUENCY
16	PROGRAMMED AMT
17	TRI/SQUARE WAVE
<u>FILTER</u>	
18	OSC/NOISE MIXER
19	CUTOFF FREQUENCY
20	RESONANCE
21	ENVELOPE AMOUNT
22	INVERT
23	ATTACK
24	DECAY
25	SUSTAIN
26	RELEASE
27	LFO
28	KEYBOARD
29	OSC TRI MOD AMT
<u>AMPLIFIER</u>	
30	ATTACK
31	DECAY
32	SUSTAIN
33	RELEASE
34	VOICE VOLUME
35	UNISON